

**203-077**

## DGUV Information 203-077



# Thermal hazards due to electric fault arcing

Guide for selecting  
Personal protective equipment

**komm****mit****mensch** is the national campaign of the German Social Accident Insurance (DGUV). Its purpose is to support companies and educational institutions in developing a culture of prevention in which all action is underpinned by safety and health. Further information at [www.kommmitmensch.de](http://www.kommmitmensch.de)

---

## Imprint

### Published by:

German Statutory Accident  
Insurance registered association (DGUV)

Glinkastraße 40  
10117 Berlin  
Germany  
Telephone: +49 30 13001-0 (switchboard)  
E-Mail: [info@dguv.de](mailto:info@dguv.de)  
Internet: [www.dguv.de](http://www.dguv.de)

Subcommittee Electrical and Precision Engineering of Expert Committee Energy Textile  
Electrical Media products sectors (ETEM) of DGUV

### Date of publication:

German edition: September 2020, English version issued July 2021

The present DGUV Information is the translation of the German edition.  
No liability is accepted for translation errors.

DGUV Information 203-077 (former number 203-078)

Obtainable from: your accident insurance institution, or at  
[www.dguv.de/publikationen](http://www.dguv.de/publikationen) Webcode: p203077

### Figures:

Cover, Figs. A 5–6, A 5–8, A 5–10, A 5–11, A 6–1, A 6–3, A 6–5 © Viktor Strasse;

Fig. A 2–1 © Dr. Holger Schau, TU Ilmenau;

Fig. A 2–2, A 2–4, A 5–2, A 6–6 © BSD GmbH;

Fig. 2–5 © Paulson Intl Ltd;

Fig. A 3–1, A 5–17, A 5–18, A 5–19, A 5–20, A 5–22 © Infraseriv GmbH & Co. Höchst KG;

Fig. A 5–14 © Michael Schäfer;

Fig. A 6–2, A 6–4 © Thomas Lanzki

# **Thermal hazards due to electric fault arcing**

Guide for the selecting  
Personal protective equipment

# Table of contents

	Page		Page
Preliminary remarks .....	7	<b>Annex 1: Directives, Regulation, Literature</b> .....	<b>26</b>
<b>1</b> <b>Scope of application</b> .....	<b>8</b>	A 1.1    EU Directives and Regulations .....	26
<b>2</b> <b>Definitions</b> .....	<b>9</b>	A 1.2    Provisions, Rules and Information for occupational safety and health .....	26
<b>3</b> <b>Performing the Risk Assessment</b> .....	<b>13</b>	A 1.3    Standards/VDE provisions .....	26
3.1    Evaluation phases .....	13	A 1.4    Literature .....	27
3.2    Case-by-case evaluation .....	16	<b>Annex 2: Standardization of PPEaA against the thermal effects of electric fault arcing</b> .....	<b>28</b>
<b>4</b> <b>Procedures for selecting PPEaA</b> .....	<b>17</b>	A 2.1    Standardization for protective clothing .....	28
4.1    Overview of the estimation process .....	17	A 2.2    Standards originating in Europe for testing protective clothing .....	28
4.2    Estimation process for AC installations .....	17	A 2.3    Standards originating in America for testing protective clothing .....	30
4.2.1   Work environment parameters .....	17	A 2.4    Standardization for other types of PPEaA .....	31
4.2.2   Determination of system electric arc energy in the event of a fault .....	17	A 2.4.1   Standards originating in Europe .....	31
4.2.3   Determining the PPEaA protection level for the work situation .....	18	A 2.4.2   Standards originating outside the EU .....	33
4.2.4   Selection of PPEaA .....	21	A 2.5    Requirements for proper selection .....	34
4.3    Estimation process for DC installations .....	21	<b>Annex 3: Parameters and risk analysis of thermal hazards to persons due to electric arcing</b> .....	<b>37</b>
4.3.1   General calculation methodology .....	21	A 3.1    General Preliminary remarks .....	37
4.3.2   Rough estimation based on reference values (worst-case considerations) .....	23	A 3.2    Energetic parameters for thermal hazards to persons due to electric arcing .....	37
<b>5</b> <b>Hints for practical implementation</b> .....	<b>24</b>	A 3.3    Methods for determining $W_{arc}$ and $W_{arc, prot}$ .....	37
		A 3.4    Work steps .....	38
		A 3.4.1   Ascertain the general operating conditions .....	38
		A 3.4.2   Calculate the short-circuit currents at the work places under study .....	39
		A 3.4.3   Determine the short-circuit duration (arc duration) .....	39
		A 3.4.4   Determine the expected value of electric arc energy .....	41
		A 3.4.5   Determine the working distance .....	43
		A 3.4.6   Determine the Arc protection level of the PPEaA .....	44
		A 3.4.7   Consider the divergent exposure relationships .....	44
		A 3.4.8   Using the analysis results for the Risk assessment .....	45
		A 3.5    Alternative test methods .....	45

	Page		Page
<b>Annex 4: Application of the Risk matrix</b> .....	<b>47</b>	<b>Annex 6: Exemplary work locations for determining transmission factor <math>k_T</math></b> .....	<b>91</b>
A 4.1 General .....	47	<b>Annex 7: Coordination of PPEaA and pre-fuses</b> .....	<b>94</b>
A 4.2 Evaluation of the anticipated severity of injury .....	48	A 7.1 Practical rules of application for the coordinated selection of PPEaA and backup fuse .....	94
A 4.3 Evaluation of the probability of occurrence .....	48	A 7.2 Selection matrix .....	94
<b>Annex 5: Examples</b> .....	<b>53</b>	A 7.3 Line protection fuses .....	95
A 5.1 Example 5.1: Low voltage distribution in a transformer station (Work location 1) .....	54	A 7.4 Transformer protection fuses .....	97
A 5.2 Example 5.2: Low voltage cable (Work location 2) .....	62	A 7.5 Safe-work fuses .....	97
A 5.3 Example 5.3: House junction box (Work location 3) .....	65	A 7.6 Minimum overcurrent factor .....	98
A 5.4 Example 5.4: Electrical installation behind the house junction box (Work location 4) .....	69	A 7.7 Permissible fuse trip times .....	99
A 5.5 Example 5.5: Removal of NH fuse-links .....	70	<b>Annex 8: Selection guide worksheets</b> .....	<b>100</b>
A 5.6 Example 5.6: Industrial distributor .....	73		
A 5.7 Example 5.7: Switching on systems of older design, not tested for electric fault arcing .....	76		
A 5.8 Example 5.8: Working on DC installations (UPS) .....	83		
A 5.8.1 Working in the vicinity of a battery or directly on the battery cells (Work location 1) .....	83		
A 5.8.2 Working in the vicinity of the inverter (DC intermediate circuit, Work location 2) .....	85		
A 5.9 Example 5.9: Working on DC installations (traction network) .....	87		



# Preliminary remarks

This DGUV Information brochure is intended to support employers in their selection of suitable personal protective equipment (e.g. protective clothing, head and face protection and gloves) against the thermal effects of an electric fault arc (PPEaA).

Persons working on or in the vicinity of live electrical equipment are, in principle, exposed to hazards associated with electric fault arcing. Electric arcs are rare, yet cannot be eliminated completely in the working environment, meaning that persons therein will require reliable protection. Arcing is not only induced by short circuiting, but can also occur when two current-carrying components are separated from each other (e.g. installation/removal of circuit protectors while under load).

The T-O-P principle for occupational safety should be used when evaluating thermal hazards and determining the measures to apply against electric fault arcing. This means that the use of personal measures (PPEaA) is viewed as being subordinate to technical and organizational measures. PPEaA is intended to minimize the remaining residual risk after the technical and organizational measures aimed at preventing an electric arc occurrence have been implemented.

Depending on the electrical network and equipment configuration, electric arcing can be extremely hazardous:

- High levels of thermal energy.
- Shock waves and associated fragments released by the explosive propagation of an arc flash.
- High intensity electromagnetic radiation, particularly in the ultraviolet (UV) and infrared (IR) radiation bands, but also in the visible light band, which can lead to irreversible damage to the eyes and skin.
- High levels of acoustic shock (blast).
- Toxic gases and particles produced by melting and vaporized materials in the vicinity of the arc flash (including electrodes)

Each consequence can, by itself, endanger the health and even the life of a person in proximity of the occurrence.

The most serious personal risks are associated with the thermal effects of electric fault arcing.

The PPEaA selection process used in this DGUV Information is based on the standardized Box test method according to DIN EN 61482-1-2 (VDE 0682-306-1-2) [11].

## Note

The procedures related to the selection of PPEaA tested in accordance with DIN EN 61482-1-1 (VDE 0682-306-1-1) [10] have already been described in NFPA 70E [14] and IEEE 1584-2018 [15]. For this reason, they are not addressed in this DGUV Information.

## Note

Furthermore, an overview of the PPEaA selection process is included in the ISSA (International Social Security Association) "Guideline for the selection of personal protective equipment when exposed to the thermal effects of an electric fault arc" (2nd edition 2011) [26].

It is recommended to perform a Risk assessment in order to evaluate the hazards associated with electric fault arcing and to facilitate subsequent PPEaA selection. In addition to the potential severity of damage, the probability of injury due to electric arcing should also be considered as part of the analysis. Section 3 of this DGUV Information describes the approaches that can be taken with respect to the thermal effects of electric arcing.

Comprehensive examples in Annex 5 as well as exemplary depictions of work locations in Annex 6 support those who apply this DGUV Information with implementation of the Risk assessment and with the calculation process. Practical rules to apply when coordinating the selection of PPEaA with pre-fused circuits (Annex 7) point the way to finding suitable PPEaA based on the fuses used or selected.

# 1 Scope of application

This DGUV Information provides guidance for action in the evaluation of potential thermal hazards due to electric fault arcing associated with electrotechnical work on electrical equipment. This DGUV Information brochure is intended to support employers in their selection of suitable personal protective equipment (PPEaA, comprised of protective clothing, headgear, face shields and gloves) against the thermal effects of an electric fault arc.

This DGUV Information applies to work tasks performed in the voltage range  $> 50 \text{ V AC/DC}$ , where a risk to persons exposed to electric fault arcing exists.

Excluded from the scope of application are:

- Applications in the high voltage range  $\geq 110 \text{ kV AC}$
- Applications in the high voltage direct-current (HVDC) transmission range.

For DC systems, the scope of application relates in practice to short-circuit arcing in the low voltage range ( $U \leq 1500 \text{ V DC}$ ).

*Note:*

*Fault arcs that develop longitudinally due to contact faults, contact separation or the like (e.g. in photovoltaic systems or on clamp connectors) are excluded. These do not generally constitute a hazard to persons (skin burns). Above all, fires can result from these electric arcs; fault arcs can also lead to short-circuits with arc flashes at high levels of current and power or energy (e.g. in battery systems), which can prove hazardous to persons.*

When working on low voltage installations, PPEaA can be dispensed with if a thermal hazard due to electric fault arcing is not anticipated. This is the case, for example:

- when working on measuring, control and regulation equipment (ICE) with upstream electric circuit protection up to 25 A.
- when working on electrical circuitry with rated voltages up to 400 V with upstream protection up to 63 A, insofar as an outfit of customary work clothing comprised of long-sleeved outer clothing and long pants is worn.
- when working on electrical circuitry with rated voltages up to 400 V AC and a short-circuit current  $< 1 \text{ kA}$  (Such an arc flash will burn unstably and extinguish immediately).

Other hazards, such as electrical shock or airborne particles may require further measures.

Within the context of an activity-related risk assessment, additional requirements related to PPE may be required, such as the capacity for electrostatic dissipation, protection against heat and flame, protection against superficial mechanical injury, etc.



## Attention

This DGUV Information offers support in the selection of PPEaA for work on both low voltage installations as well as high voltage installations lower than 110 kV AC.

Exemplary work locations:

- Household installations,
- Power distribution networks,
- Industrial networks.

This DGUV Information does not address potential hazards associated with the collateral effects of electric arcing, such as those due to pressure, acoustic shock, particles flying off, radiation, molten particles or gases.

**Neither does it apply** to the use of electrical equipment conforming to pertinent guidelines or standards, which have been designed or installed for use by unskilled persons.



## 2 Definitions

### Personal protective equipment against the thermal effects of an electric fault arc (PPEaA)

Personal protective equipment against the thermal effects of an electric fault arc (PPEaA) applies to any item meant to be worn or held by a person for protection against the thermal hazards associated with electric fault arcing.

### Work

Any form of electrotechnical or non-electrotechnical activity where the potential for an electrical hazard exists.

### Live working

Any work-related activity, because of which a person, either physically or through the use of tooling, equipment or devices, knowingly comes in contact with or enters a danger zone associated with live components according to VDE 0105-100.

### Work performed in the vicinity of live components

All work-related activities, because of which a person, either with parts of the body or through the use of tooling or other objects, enters the vicinity zone according to VDE 0105-100 without entering a danger zone according to VDE 0105-100.

### Working distance $a$

Working distance  $a$  is the distance between the electric fault arc and the operative part of a person's body (torso) while performing work or while present in the working environment under consideration.

*Note 1 regarding the term:*

Working distance is denoted in mm.

### Equivalent arc energy

The protection level of the PPEaA  $W_{\text{arc, prot}}$  resulting from the test level  $W_{\text{arc, test}}$  at a fixed working distance  $a$ , as well as the transmission factor  $k_T$ .

*Note 1 regarding the term:*

Equivalent arc energy is denoted in kJ or kWs.

*Note 2 regarding the term:*

Equivalent arc energy was denoted with  $W_{\text{arc, prot}}$  in the 2012 Edition of this DGVU Information.

### Normalized arc power $k_p$

The relationship of electric arc power to short-circuit power in the electrical network at the fault location.  $k_p$  considers the physical properties of “electric arc voltage” and “electric arc current”.

### Sustained short-circuit current $I_{\text{kDC}}$

The stationary value of short-circuit direct current with a bolted short-circuit at the fault location.

*Note 1 regarding the term:*

Sustained short-circuit current is denoted in kA.

### Direct incident energy $E_{i0}$

Heat energy emanating directly from the electric fault arc per unit of affected area.

*Note 1 regarding the term:*

Direct incident energy is denoted in kJ/m<sup>2</sup> or kWs/m<sup>2</sup> (cal/cm<sup>2</sup>).<sup>1</sup>

### Transmitted incident energy $E_{it}$

Incident energy that penetrates PPEaA due to electric arc exposure; a portion of the direct incident energy.

*Note 1 regarding the term:*

Direct incident energy is denoted in kJ/m<sup>2</sup> or kWs/m<sup>2</sup> (cal/cm<sup>2</sup>).<sup>1</sup>

### Incident energy $E_i$

The heat energy (total heat quantity) impacting an exposed surface in a certain distance as a result of electric fault arcing.

*Note 1 regarding the term:*

Direct incident energy is denoted in kJ/m<sup>2</sup> or kWs/m<sup>2</sup> (cal/cm<sup>2</sup>).<sup>1</sup>

### Electrical system

Overall electric installations and equipment used for producing, transmitting, converting, distributing and utilizing electrical energy.

### Electrode gap $d$

Distance between the arcing electrodes.

*Note 1 regarding the term:*

The electrode gap is denoted in mm.

<sup>1</sup> Correlation:

1 cal/cm<sup>2</sup> = 41.868 kJ/m<sup>2</sup>, 1 kJ/m<sup>2</sup> = 0.023 885 cal/cm<sup>2</sup>

### Short-circuit duration $t_k$

Period of the short-circuit in time.

*Note 1 regarding the term:*

Short-circuit duration is denoted in s.

### Short-circuit power $P_k$ (DC range) or $S_k''$ (AC range)

A virtual value calculated as a product of the prospective short-circuit current at a point on the network and the nominal network voltage (or contracted supply voltage).

For three-phase AC systems, the factor  $\sqrt{3}$  is to be accounted for; the short-circuit current corresponds to the 3-phase initial short-circuit AC current  $I_k''$  (VDE 0102 [8]).

*Note 1 regarding the term:*

Short-circuit power is denoted in kVA (AC), kW (DC).

### Arc duration $t_{arc}$

Period of the electric fault arc in time.

*Note 1 regarding the term:*

Arc duration is denoted in s.

### Electric arc energy $W_{arc}$

Electrical energy that causes electric arcing and is converted into an arc flash.

*Note 1 regarding the term:*

Electric arc energy is calculated as the sum (integral) of the product of the instantaneous values of arc voltage and arc current, as well as the time differential developing over the duration of arcing. In three-phase AC systems, the electric arc is generally a multi-pole (usually three-pole) fault; the arc energy in this context is the total energy of all contributing electric arcs.

*Note 2 regarding the term:*

Electric arc energy is denoted in kJ or kW.s.

### Electric arc short-circuit current $I_{k, arc}$

Current (due to electric arcing) actually flowing (through the arc) at the fault location throughout the arc duration.

*Note 1 regarding the term:*

The electric arc short-circuit current is determined as the average effective value over the duration of the short-circuit (AC) or the average value over the virtual steady-state phase of the short-circuit (DC).

*Note 2 regarding the term:*

Electric arc short-circuit current is denoted in kA.

### Electric arc power $P_{arc}$

Active power converted into electric arcing; a product of the electric arc current and the electric arc voltage.

*Note 1 regarding the term:*

Electric arc power is denoted in kW.

### Materials

Textile fabrics or other materials used to produce single or multilayer PPEaA.

### Prospective short-circuit current

Expected current that flows when a fault location is short-circuited through a conductor with negligible impedance (bolted short-circuit of the electrical supply).

*Note 1 regarding the term:*

Prospective short-circuit current is denoted in kA.

*Note 2 regarding the term:*

There is a basic difference between the actual electric arc short-circuit current and the prospective short-circuit current. The actual electric arc short-circuit current flowing throughout the arc duration is lower and fluctuates due to the non-linear arc impedance that varies indeterminately over time.

### Test level $W_{arc, test}$

Electric arc energy set as part of the Box test (according to VDE 0682-306-1-2 [11]) for either of the two electric fault arc test categories and leading to a direct incident energy  $E_{iOP}$ .

*Note 1 regarding the term:*

The test level is denoted in kJ or kW.s.

### Test current $I_{APC}$

Prospective short-circuit current in the electrical test current circuit (expected) used for setting a test category in the Box test method; effective value (symmetrical AC component).

*Note 1 regarding the term:*

Test current is denoted in kA.

### Residual risk

The risk of personal injury that remains due to electric arc exposure – after the measures aimed at preventing an electric arc occurrence and its effects have been implemented. Residual risk results from the combination of

- the anticipated severity of injury and the
- probability of injury, while accounting for the respective adopted measures.

**R/X-ratio**

Relationship of the ohmic resistance to the inductive reactance of a short-circuit electrical circuit.

**PPEaA protection level  $W_{\text{arc, prot}}$** 

Electric arc energy level, up to which the PPEaA offers protection against the thermal effects of electric fault arcing; the PPEaA parameters with a given transmission factor  $k_T$  and working distance  $a$ ; correspond to the equivalent arc energy.

*Note 1 regarding the term:*

*Protection level is denoted in kJ or kWs.*

**Stoll curve**

Correlation between thermal incident energy and exposure time derived from data related to the tolerance behaviour of human skin when exposed to heat; specifies the limits for the occurrence of second-degree skin burns.

**Current limiting factor  $k_B$** 

Relationship between the actual electric arc short-circuit current and the prospective short-circuit current.

**Electric fault arc**

A self-sustaining gas discharge due to a faulty connection between conductive components of different potential in an electric installation.

*Note 1 regarding the term:*

*Electric fault arcing in the context of this DGUV Information is considered to be an undesirable faulty occurrence caused by short-circuiting.*

**Arc protection class APC**

Categories of thermal protection afforded by PPEaA against the thermal effects of an electric fault arc, as tested using the Box test method (according to VDE 0682-306-1-2 [11]). Arc protection classes (APC) are distinguished by the tested energy levels ( $W_{\text{arc, test}}$  und  $E_{\text{iOP}}$ ).

**T-O-P principle**

The T-O-P principle determines the order of priority of the protective measures implemented by a company to protect its employees against hazards: first technical, then organisational and lastly personal measures.

- **Technical measures**  
Safety-relevant installation and maintenance of machinery and equipment, operating facilities, working and social areas.
- **Organizational measures**  
Rules to facilitate safe working practices, such as operating instructions and safety-related information.
- **Personal measures**  
Personal protective equipment, qualifications (e.g. special training or instruction).

**Transmission factor  $k_T$** 

A factor describing the spatial propagation of the thermal impact of an electric arc on the working environment. It is determined by the geometric relationships between the installations at the work location.

**Transmission and exposure conditions**

Totality of the influences on the heat transfer associated with an electric fault arc.

**Initial short-circuit current  $I_k''$** 

The effective value of the short-circuit current's AC component at the beginning of the short-circuit event in an AC or a three-phase AC installation (AC system) with bolted short-circuiting.

*Note 1 regarding the term:*

*Initial short-circuit AC current is denoted in kA.*

*Note 2 regarding the term:*

*A maximum value  $I_{k\text{max}}''$  and a minimum value  $I_{k\text{min}}''$  of the initial short-circuit AC current are determined in the standardized short-circuit current calculation.*

**Nominal network voltage  $U_{Nn}$** 

Voltage between the conductors intended for a network, by which the network is designated or identified, and which pertains to specific operating characteristics.

*Note 1 regarding the term:*

*Nominal network voltage is denoted in V.*

**Electric arc voltage  $U_{\text{arc}}$** 

Average value of the voltage associated with an electric fault arc that occurs between the electrodes (conductors).

*Note 1 regarding the term:*

*Electric arc voltage is denoted in V.*

**Time constant  $\tau$**

A measure of the current reaction time with a change in voltage, dependent upon the  $L/R$  ratio in the electric circuit.

*Note 1 regarding the term:*

*Time constant is denoted in ms.*

**Threshold energy  $W_{arc, min}$**

The threshold value of electric arc energy (50 kJ), beyond which the use of PPEaA is required.

**Table 2-1** Symbols and units

Symbols		Units
$a$	Working distance	mm
$d$	Electrode gap	mm
$E_i$	Incident energy	kJ/m <sup>2</sup> oder kWs/m <sup>2</sup> + cal/cm <sup>2</sup>
$E_{i0}$	Direct incident energy	kJ/m <sup>2</sup> oder kWs/m <sup>2</sup> (cal/cm <sup>2</sup> )
$E_{it}$	Transmitted incident energy	kJ/m <sup>2</sup> oder kWs/m <sup>2</sup> (cal/cm <sup>2</sup> )
$I_{APC}$	Test current	kA
$I_{k, arc}$	Electric arc short circuit current	kA
$I_{kDC}$	Sustained short-circuit current DC	kA
$I_{k, arc}$	LElectric arc short-circuit current	kA
$k_B$	Current limiting factor	
$k_P$	Normalized arc power	
$k_T$	Transmission factor	
$t_k$	Short-circuit duration	s
$t$	Time constant	ms
$R/X$	Impedance ratio	
$U_{arc}$	Electric arc voltage	V
$U_{Nn}$	Nominal network voltage	V
$W_{arc}$	Electric arc energy	kJ or kWs
$W_{arc, min}$	Threshold energy	kJ or kWs
$W_{arc, prot}$	PPEaA protection level (equivalent electric arc energy)	kJ or kWs
$W_{arc, test}$	Test level	kJ oder kWs
$P_k$	Short-circuit power (DC)	kW
$S''_k$	Short-circuit power (AC)	kVA

# 3 Performing the Risk Assessment

(Thermal effects of electric fault arcing)

## 3.1 Evaluation phases

A Risk assessment must be carried out by the employer within the context of an evaluation of working conditions in accordance with Article 5 of the German Occupational Safety and Health Act (ArbSchG) [2] and DGUV Regulation 1 “Principles of Prevention” [3].

A sensible approach with regard to the thermal effects of electric fault arcing is depicted in the flow diagram in Fig. 3-1.

The individual phases of the Risk assessment are:

### *Phase 1: Is there a principle danger to persons from exposure due to electric fault arcing?*

An estimation is made for the specific work situation as to whether electric fault arcing should be anticipated. In this process and on the basis of one’s own company, the structure, condition and age of the installation, the intended work activity, as well as the qualifications and experience of the executing personnel, for example, should be considered.

If the results show that there is no danger to persons from exposure to electric fault arcing, then PPEaA is not required.

### *Phase 2: Initial evaluation of the electric arc energy associated with the scope of activity or workplace. Is a calculation required?*

Although there are work areas and activities where the onset of electric fault arcing cannot be ruled out, there are also areas where the expected amount of electric arc energy is so small that a hazard due to its thermal effects is not expected.

It is therefore set forth in the Scope of Application (Section 1) of this DGUV Information that the use of PPEaA can be dispensed with in the following cases:

- When working on measuring, control and regulation equipment with upstream electric circuit protection up to 25 A.
- When working on electrical circuitry with rated voltages up to 400 V with upstream protection up to 63 A, insofar as an outfit of customary work clothing comprised of long-sleeved outer clothing and long pants is worn.

- When working on electrical circuitry with rated voltages up to 400 V AC and a short-circuit current  $< 1$  kA. (This type of electric arc will burn unstably and extinguish immediately.)

If one of the applications mentioned above applies, then neither PPEaA nor a calculation is required.

### *Phase 3: Apply the calculation methodology: determine the electric arc energy $W_{arc}$ , and level of PPEaA protection $W_{arc, prot}$ !*

The calculation process for the selection of PPEaA, as described in Section 4, is applied during this phase.

Four different results are possible:

- $W_{arc} < W_{arc, min}$   
The expected electric arc energy is less than the minimum value of 50 kJ, beyond which skin burns due to direct exposure cannot be ruled out ( $W_{arc, min}$ ). This means that PPEaA is not required.
- $W_{arc} \leq W_{arc, prot\_APC 1}$   
The expected electric arc energy is less than the PPEaA protection level  $W_{arc, prot}$  with a class APC 1. PPEaA in the Arc protection classes APC 1 or APC 2 provides sufficient protection against the thermal effects of an electric fault arc.
- $W_{arc} \leq W_{arc, prot\_APC 2}$   
The expected electric arc energy is less than the PPEaA protection level  $W_{arc, prot}$  with a class APC 2. PPEaA in the Arc protection class APC 2 provides sufficient protection against the thermal effects of an electric fault arc.
- $W_{arc} > W_{arc, prot\_APC x}$   
The expected electric arc energy is greater than the PPEaA protection level  $W_{arc, prot\_APC x}$  (Arc protection classes APC 1 or APC 2) provided by the PPEaA available. In this case, proceed with Phase 4.

### *Phase 4: Implement further measures towards reducing electric arc energy and the probability of injury due to electric fault arcing.*

Further measures towards reducing electric arc energy and the probability of injury due to electric fault arcing must be adopted and implemented.

Performing the Risk Assessment

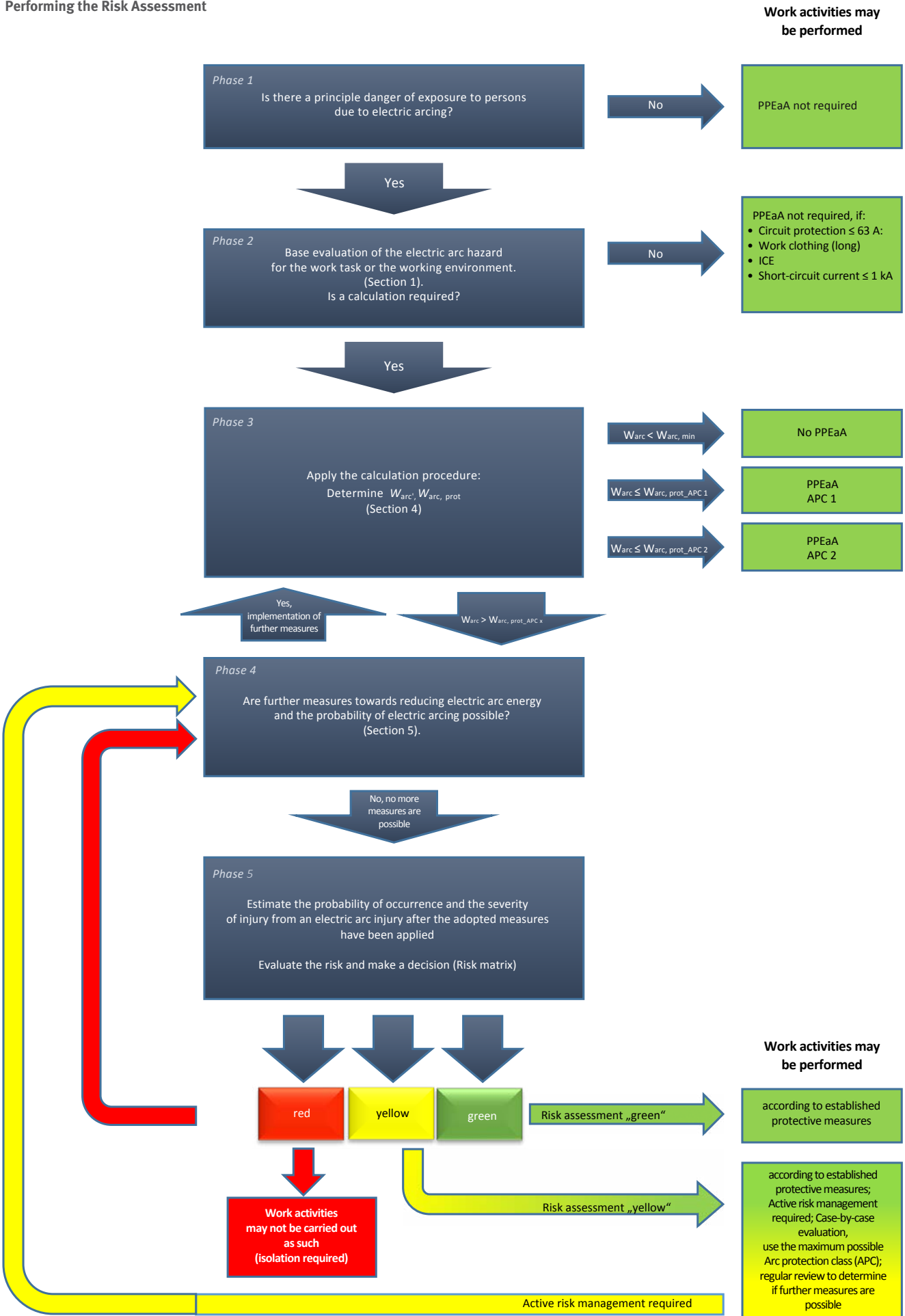

Fig. 3-1 Risk assessment flow diagram

Instructions for possible measures are described in Section 5, "Instructions for practical application".

The Risk assessment must be carried out again subsequent to Phase 3. If no further measures towards reducing electric arc energy and the probability of injury due to electric fault arcing are possible, then proceed with Phase 5.

*Phase 5: Estimate the probability of occurrence and the severity of injury due to electric fault arcing after the adopted measures have been implemented; evaluate the residual risk and make a decision (Risk matrix)*

If the protection level  $W_{arc, prot}$  afforded by the PPEaA available is less than the arc energy  $W_{arc}$  determined in Phase 3, then the Risk assessment can be expanded to consider the probability of personal injury. An estimation of risk can be undertaken in so doing.

The starting point for estimating the risk in Phase 4 should always be the precise calculation of the expected electric arc energy in Phase 3, not a worst-case estimation on the basis of reference or extreme values, which is also an option there.

The residual risk of an injury due to the effects of electric arcing must be evaluated after the measures aimed at preventing an electric arc occurrence and its effects have been implemented.

This residual risk results from the combination of

- the anticipated severity of injury and the
- probability of injury, while accounting for the respective adopted measures.

Assistance in determining the anticipated severity of injury and the probability of this injury occurring can be found in Annex 4 of this DGUV Information.

*Using the Risk matrix*

When using the risk matrix (Fig. 3-2), probability of injury and the severity of a possible injury due to the effects of electric fault arcing must be applied - while accounting for the respective adopted measures.

According to the Risk assessment flow diagram (Fig. 3-1), a classification in the "Red" category calls for the adoption and evaluation of further measures (Phase 4), or the work must be performed only with all relevant system components in an isolated state. Adjacent live parts of the installation must be covered or gated.

	Probability of injury (evaluation points)	1 (0 to 9)	2 (10 to 19)	3 (20 to 30)	4 (31 to 45)	5 (46 to 60)
Severity of damage (Severity of injury)		Practically impossible	Conceivable, but very unlikely	Unlikely	Seldom	Occasional to frequent
1	Slight injury					
2	Reversible injury					
3	Irreversible injury					
4	Fatal injury					
Legend:						
	Green Work activities may be performed					
	Yellow Active risk management required; Case-by-case evaluation, (refer to 3.2); regular review to determine if further measures are possible (a deadline must be set)					
	Red Work activities may not be carried out as such (switching off the power supply required); if possible, implement further measures according to Phase 5					

Fig. 3-2 Risk matrix: Risk of injury after implementing the adopted measures

### 3.2 Case-by-case evaluation

Evaluations on a case-by-case basis must address specific situations. Other framing conditions (e.g. ergonomics, acceptance, etc.) must also be considered, while potential/sensible technical and organizational measures are to be adopted in order to achieve the following exemplary provisions:

- The PPEaA class APC 1 available in the company may be used on a case-by-case basis for a specific task on a specific installation.
- The PPEaA class APC 2 is to be used where the expected electric arc energy is higher than class APC 2.
- The PPEaA class APC 2, which is demonstrably capable of providing protection against higher thermal loading (verified through testing at higher test levels using the Box test method), is to be used where the expected electric arc energy is higher than class APC 2.



# 4 Procedures for selecting PPEaA

## 4.1 Overview of the estimation process

The first step is to estimate the electric arc energy  $W_{arc}$  converted at the workplace in the event of a fault. This is then compared with the protection level (equivalent arc energy)  $W_{arc, prot}$ , up to which PPEaA provides protection, while accounting for the geometry of the installation and the working distance.

The estimation process for an AC installation is described in Section 4.2. The approach described in Section 4.2 can also be applied in a figurative sense to the estimation process for DC installations. Particular aspects that apply specifically to DC systems, however, are described in Section 4.3.

## 4.2 Estimation process for AC installations

### 4.2.1 Work environment parameters

The working environment in an electrical installation is characterized by the following parameters:

**Table 4-1** Work environment parameters

Work environment			
Overcurrent protective devices	Electrical network		Electrical system
$t_k$	$U_{Nn}$ $R/X$	$S''_k$	$d$

### 4.2.2 Determination of system electric arc energy in the event of a fault

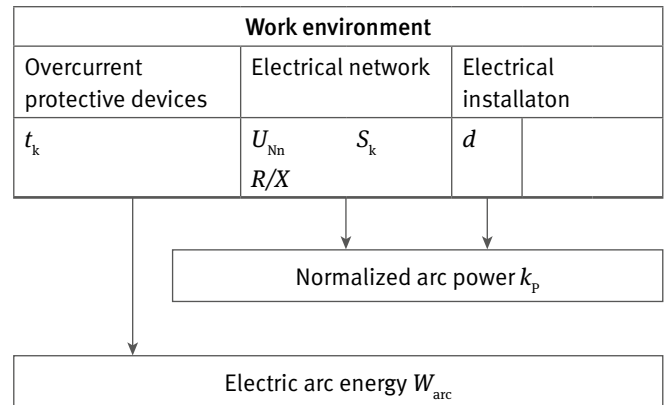

Fig. 4-2 Determination of electric arc energy

The actual electric arc short-circuit current  $I_{k, arc}$  in the low voltage range is significantly lower than the short-circuit current  $I''_{k3}$  calculated for the installation (a minimal value of the initial 3-pole short-circuit AC current is assumed in this context) due to the limiting characteristics of the electric fault arc. In principle, the applicable correlation is:

$$I_{k, arc} = k_B \cdot I''_{k3 \min} \quad (\text{also refer to A 3.4.2})$$

The current limiting factor  $k_B$  cannot be precisely determined, but can be ascertained, for example, from a diagram in [21]. Refer to Table 4-2 for reference values.

The limiting properties of the electric fault arc can be disregarded in the  $> 1 \text{ kV}$  range. The following applies:  $k_B = 1$ .

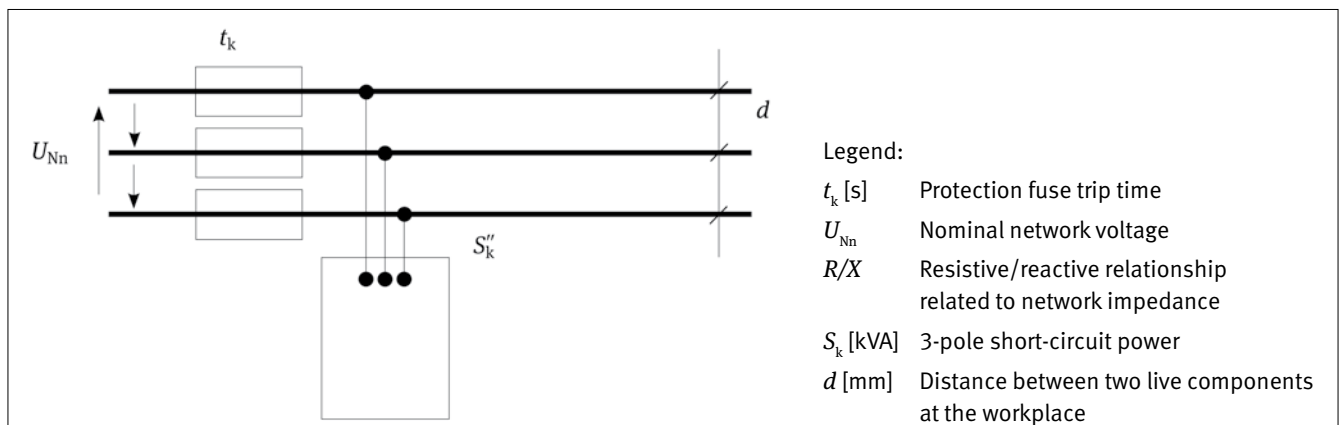

Fig. 4-1 Electrical system parameters

The low voltage range is generally considered to be safe if one assumes a current limitation of 50 % and uses this reduced current to ascertain the trip time from the protection characteristic curve. The current limiting factor then equates to  $k_B = 0.5$ ; it follows that  $I_{k, \text{arc}} = 0.5 \cdot I''_{k3, \text{min}}$

The short-circuit duration  $t_k$ , which is also the arc duration  $t_{\text{arc}}$ , is now determined using the overcurrent protection characteristics and the electric arc short-circuit current  $I_{k, \text{arc}}$  determined (refer also to A 3.4.3).

The trip time is determined using the minimum 3-phase short-circuit current  $I''_{k3, \text{min}}$  (worst-case scenario) (refer also to Fig. 4-3).

With short-circuit durations of longer than 1 s, it can be assumed that the person will be able to withdraw from the immediate danger area, if necessary. For this reason, longer periods will not need to be considered. This does not apply, however, if the person's departure from the work environment is precluded or restricted (e.g. working in tight cable trenches or canals, narrow work corridors, work from ladders or lifting mechanisms).

Arc energy  $W_{\text{arc}}$  is determined by the electric arc power  $P_{\text{arc}}$  and the arc duration  $t_{\text{arc}}$ , which corresponds to the short-circuit duration  $t_k$  up to the trip time of the overcurrent protection device:

$$W_{\text{arc}} = P_{\text{arc}} \cdot t_{\text{arc}}$$

Electric arc power  $P_{\text{arc}}$  is dependent upon the type of arc formation and the geometry of the live components at the fault location. It is determined using the normalized arc power  $k_p$  from the short-circuit power  $S''_k$  with the equation  $P_{\text{arc}} = k_p \cdot S''_k$ .

Normalized arc power  $k_p$  can be determined with consideration given to the effective electrode gap  $d$  (equipment conductor spacing), e.g. according to the text in German, "Schau, H.; Halinka, A.; Winkler, W.: Elektrische Schutzrichtungen in Industriernetzen und -anlagen" [21]. Reference values for  $k_p$  are specified in Table A 3-2 in Annex 3.

In general, an estimation of arc energy in the event of a fault results in the correlation:

$$W_{\text{arc}} = k_p \cdot S''_k \cdot t_k$$

**Table 4-2** Current limiting factor reference values for a worst-case calculation

Voltage range	Current limiting factor (reference values) $k_B$
Low voltage	0.5
Medium and high voltage	1.0

With the short-circuit power  $S''_k = \sqrt{3} \cdot U_{\text{Nn}} \cdot I''_{k3, \text{max}}$  follows  $W_{\text{arc}} = k_p \cdot \sqrt{3} \cdot U_{\text{Nn}} \cdot I''_{k3, \text{max}} \cdot t_k$

For worst-case considerations,  $k_p$  can be replaced by the maximum value  $k_{p\text{max}}$ :

$$k_{p\text{max}} = \frac{0.29}{(R/X)^{0.17}}$$

The decisive short-circuit current  $I''_{k3}$  is the prospective 3-pole short-circuit current at the workplace (fault location). This is the result of a short-circuit current calculation (refer to Annex A 3.4.2 and VDE 0102); for this, the maximum value for the 3-pole initial short-circuit AC current must be assumed.

The duration of arc combustion  $t_{\text{arc}}$  corresponds to the short-circuit duration  $t_k$  and is determined by the overcurrent protection devices. The short-circuit duration can generally be derived the overcurrent protection device manufacturer's selectivity evaluations and/or trip time characteristic curves (current-time curves).

#### 4.2.3 Determining the PPEaA protection level for the work situation

The protection level  $W_{\text{arc, prot}}$  afforded by PPEaA is determined by the test level of the PPEaA and the working distance  $a$ , as well as the geometry of the installation (factor  $k_T$ ) (refer to Fig. 4-4).

Working distance  $a$  is the distance between the electric fault arc and the operative part of a person's body (torso) while performing work or while present in the working environment under consideration. Where different tasks are being carried out in the working environment, the shortest operative distance should be applied.

It can be assumed that the distance to a person's torso while working will not be lower than  $a = 300$  mm. Different distances may be considered for PPEaA intended



Fig. 4-3 Example for determining the trip time for an overcurrent protection device

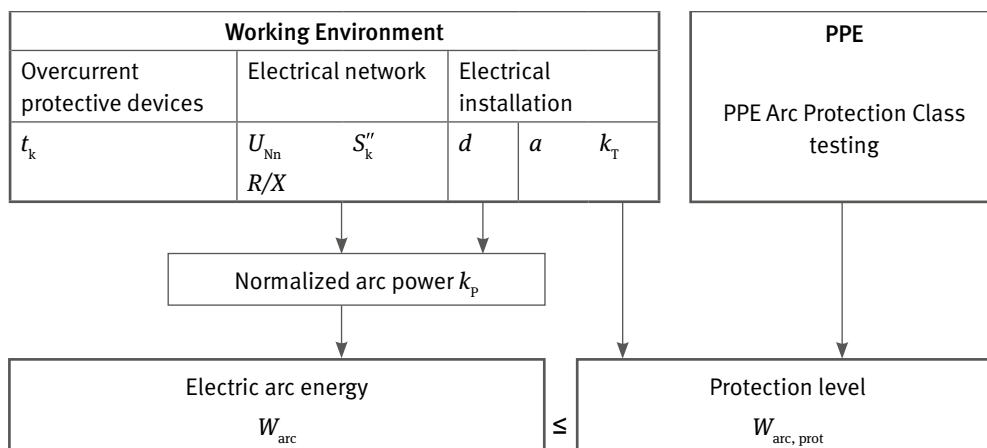

Fig. 4-4 Determination of the protection level

for other parts of the body (e.g. head, legs, etc.). Typical values are referenced in Annex A 3.4.5, Table A 3-3.

Protection of the hands is possible only to a limited extent. If the hands are located in the immediate vicinity of an electric fault arc, then an assertion as to the level of protection afforded the hands cannot be made. However, experience gained from actual accidents reveals that, in all cases where burn injuries to the hands have occurred, protective gloves were not worn. Hands are usually drawn away instinctively as a reflex action when a fault occurs. For this reason, protective gloves that have been arc fault tested are recommended.

The transmission factor  $k_T$  considers the electrical system's geometric configuration and describes the spatial propagation of the thermal impact of an electric arc.

In a small-scale installation, the thermal influence of an arc flash propagates directionally. In more open or spacious installations, the thermal influence will propagate in a more omnidirectional pattern (refer to Fig. 4-5).

Exemplary pictures of actual on-site work situations are depicted in Section 6.

The test method used to verify the thermal impact of an electric fault arc is described in detail in Section A 2.2. This test method distinguishes between two Arc protection classes (APC), which define the protection afforded by PPEaA against the thermal effects of electric arcing. Verification for both Arc protection classes is by subjection to electric arcing at the resulting arc energy intensity (test level), using the test setups described in the test method.

Arc protection class APC 1	$W_{\text{arc, test\_APC1}} = 168 \text{ kJ}$
Arc protection class APC 2	$W_{\text{arc, test\_APC2}} = 320 \text{ kJ}$

Equivalent arc energy  $W_{\text{arc, prot}}$  can be determined from the electric arc energy of test category  $W_{\text{arc, test}}$  for any working distance  $a$  ( $\geq 300 \text{ mm}$ ) using the formula below. It represents the protection level  $W_{\text{arc, prot}}$ , at which the protection afforded by the PPEaA for the respective distance  $a$  is still maintained.<sup>2</sup> Moreover, using the factor  $k_T$  allows the system configuration to be accounted for.

The following formula applies in general on the basis of the Box test method:

$$W_{\text{arc, prot}} = k_T \cdot \left( \frac{a}{300 \text{ mm}} \right)^2 \cdot W_{\text{arc, test}} \quad (\text{for } a \geq 300 \text{ mm})$$

<sup>2</sup> Feasibility study in German – “Machbarkeitsuntersuchung zur Prüfung und Bewertung von Schutzhandschuhen gegen thermische Gefahren von Störlichtbögen” (AG: BGFE; AN: STFI/TU Ilmenau), STFI final report from 30 May 2005

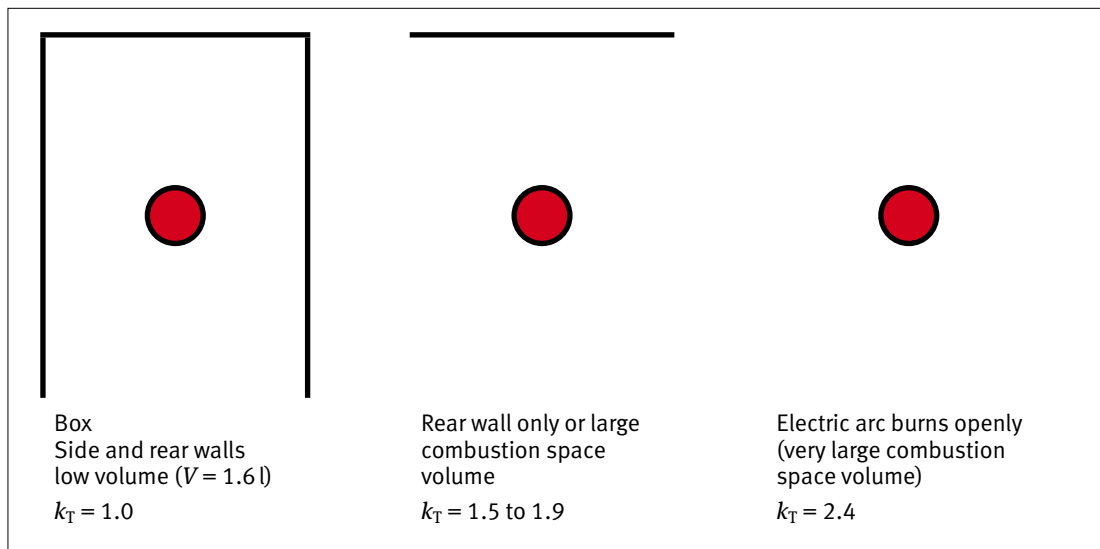

Fig. 4-5  
Transmission factor reference values for different installation relationships

Note:

This formula is valid only for the calculation and the selection of PPEaA that has been tested under (IEC 61482-1-2) standardized conditions ( $a = 300 \text{ mm}$ , APC 1 or APC 2).

#### 4.2.4 Selection of PPEaA

Insofar as the expected value of the electric arc energy  $W_{\text{arc}}$  does not fall below a value of 50 kJ, the relationship to the expected value of the electric arc energy  $W_{\text{arc}}$  is to be accounted for on the basis of the protection level  $W_{\text{arc, prot}}$  used for choosing the PPEaA Arc protection class (Box test according to IEC 61482-1-2). The thermal hazards associated with electric fault arcing are deemed to have been met if  $W_{\text{arc}} \leq W_{\text{arc, prot}}$  applies.

On the basis of this relationship, with application of the determinants and conditional equations referenced above, limitations for the use of PPEaA in a selected Arc protection class can also be determined with respect to

- the short-circuit current range,
- the permissible short-circuit duration or the trip time of the overcurrent protection device (and with that the overcurrent protection device, itself),
- and the permissible working distance (also refer to Annex 7).

A summary of the estimation process for AC installations is depicted in Fig. 4-6.

## 4.3 Estimation process for DC installations

### 4.3.1 General calculation methodology

The assertions that follow apply to low voltage DC installations (LVDC).

Note:

The algorithm applies in particular to direct current circuits, in which a virtual steady-state short-circuit current relationship has set in and/or the short-circuit duration is significantly greater than the DC circuit time constant  $\tau = L/R$ .

Cases where the time constant is greater and the short-circuit duration is shorter are covered by the calculation base; the results, under certain circumstances, will then encompass safety reserves to a greater degree.

The work environment in DC installations is characterized by the electric parameters

$U_{\text{Nn}}$	Nominal voltage of the DC system (network)
$R_{\text{N}}$	Total ohmic resistance of the DC system
$P_{\text{k}}$	Short-circuit power of the DC system (fault location) as well as
$d$	Electrode gap in the DC installation
$t_{\text{k}}$	Trip time of the upstream overcurrent protection fuse (short-circuit duration)

The ohmic resistance of the DC network is comprised of the internal resistance of the DC source (rectifier with an upstream AC network, inverter, battery), the line resistance and the resistance of other elements in the DC circuit (e.g. inductors, etc.).

The short-circuit power in the DC system  $P_{\text{k}}$  results from the nominal DC source voltage and the sustained short-circuit current  $I_{\text{kDC}}$  (stationary value of the short-circuit direct current with a bolted short-circuit at the fault location):

$$P_{\text{k}} = U_{\text{Nn}} \cdot I_{\text{kDC}} = U_{\text{Nn}}^2 / R_{\text{N}}$$

Note:

The arithmetic mean current value after the transients have subsided is to be considered as the sustained short-circuit current on rectifier-supplied DC systems.

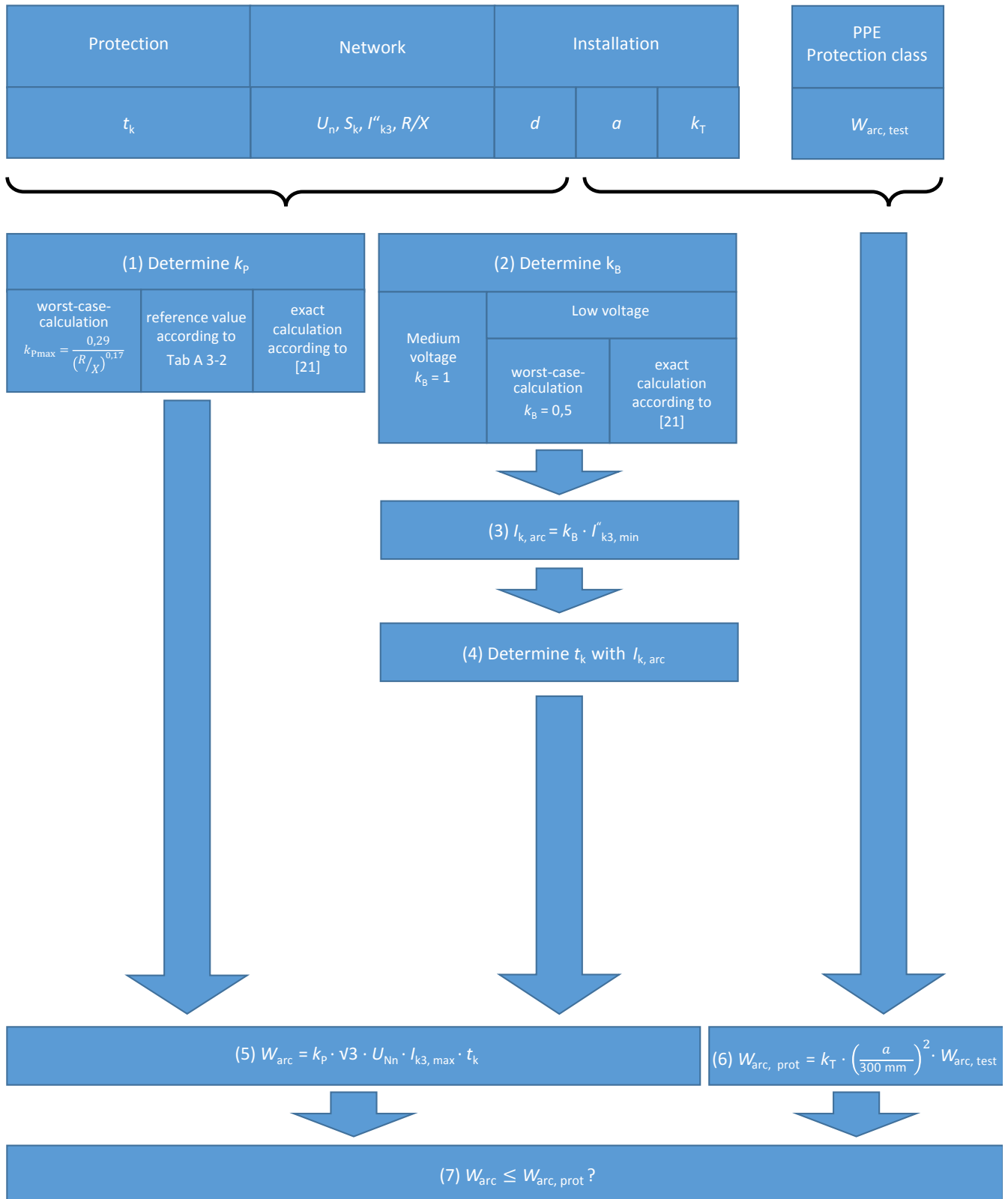

Fig. 4-6 Summary of the estimation process for AC installations

The electric arc short-circuit current  $I_{k, \text{arc}}$ , the current limiting factor  $k_B$  and the electric arc power  $P_{\text{arc}}$  are determined iteratively by approximating the current-voltage characteristics

$$U_{\text{arc}} = (34 + 0.532 \cdot d) \cdot I_{k, \text{arc}}^{0.12}$$

using electrode gap  $d$  (the equation applies for the electric arc voltage in V, the electric arc short-circuit current  $I_{k, \text{arc}}$  in A and the electrode gap  $d$  in mm). The recursion rule applies in general for the iteration ( $i$  and  $i+1$  are consecutive iteration steps):

$$I_{k, \text{arc}}^{(i+1)} = \frac{U_{\text{Nn}}}{R_{\text{arc}}^{(i)} + R_{\text{N}}} = \frac{U_{\text{Nn}}}{\frac{(34 + 0.532 \cdot d)}{I_{k, \text{arc}}^{(i)0.88}} + \frac{U_{\text{Nn}}}{I_{\text{kDC}}}}$$

This iteration is undertaken up to a designated abort criterion with specification of an initial value  $I_{k, \text{arc}}^{(0)}$ .

The following applies for electric arc power

$$\begin{aligned} P_{\text{arc}}^{(i+1)} &= U_{\text{arc}}^{(i+1)} \cdot I_{k, \text{arc}}^{(i+1)} \\ &= \frac{U_{\text{Nn}} \cdot (34 + 0.532 \cdot d) \cdot I_{k, \text{arc}}^{(i+1)0.12}}{\frac{(34 + 0.532 \cdot d)}{I_{k, \text{arc}}^{(i)0.88}} + \frac{U_{\text{Nn}}}{I_{\text{kDC}}}} \end{aligned}$$

*Note:*

*For expediency, an initial value of  $I_{k, \text{arc}}^{(0)} = 0,5 I_{\text{kDC}}$  is assumed. The iteration process will be aborted if the results from two consecutive iteration steps fall below a predefined deviation (e.g. 0.5 %).*

Normalized arc power can be derived from

$$k_P = \frac{P_{\text{arc}}}{P_k} .$$

The expected value of the electric arc energy is calculated

$$W_{\text{arc}} = P_{\text{arc}} \cdot t_{\text{arc}} = k_P \cdot P_k \cdot t_{\text{arc}}$$

on the basis of the electric arc power or normalized arc power. The arc duration  $t_{\text{arc}}$  or short-circuit duration  $t_k$  is determined by the protection settings or protective device characteristic curve analogous to the AC process on the basis of the electric arc short-circuit current  $I_{k, \text{arc}}$ .

*Note:*

*When determining the short-circuit duration from the characteristic curves specified by the manufacturer (e.g. circuit protectors), the time constant  $L/R$  of the DC system is to be accounted for, if applicable.*

The protection level of the PPEaA is determined and evaluated in a manner analogous to the method used for AC installations (Sec. 4.2.3).

#### 4.3.2 Rough estimation based on reference values (worst-case considerations)

For very rough estimations of the electric arc power, the reference value  $k_{P\text{max}} = 0.25$  can be used in the DC range:

$$P_{\text{arc}} = k_{P\text{max}} \cdot P_k = 0.25 \cdot P_k$$

Application of the iteration process is no longer necessary.

For the low voltage range, one is usually on the safe side with DC systems if a reference value of  $k_B = 0.5$  is used for the current limiting factor.

# 5 Hints for practical implementation

Worksheets (Excel) have been developed to assist in applying this process. These are available in the Download section on the Internet website of the DGUV Department of Subcommittee Electrical Engineering and Precision Mechanics ([www.dguv.de](http://www.dguv.de); Webcode: d1183022).



The alternative steps below can be used when applying the calculation methodology in order to achieve more precise results.

- If the maximum value  $k_{p_{max}}$  was used to determine normalized arc power  $k_p$  in the initial calculation, it is considered a safe calculation, but may go well beyond the target in practice. In this case, it may be worthwhile to calculate using a typical reference value or by considering the system configuration in actual practice.
- When determining the current limiting factor  $k_B$ , a (worst-case) value of 0.5 can be assumed for electric arcing in the low voltage network. As a rule, a calculation of the current limiting factor according to the more precise method [21] results in a  $k_B$  value  $> 0.5$  and, therefore, can lead to significantly low arc energy levels, e.g. when the short-circuit shutdown occurs due to fuses with trip times  $< 1$  s (refer to the examples in Annex 5).
- The geometry of the real installation is entered into the calculation. The transmission factor  $k_T$ , which is normally determined during the initial approximation, can be adapted based on the actual geometric system conditions and the working environment. If a deviation from transmission factor  $k_T = 1$  is intentional, this determination must be justified.

If application of the risk assessment in Phase 3 determines that the protection afforded by the PPEaA selected for the work process under consideration is not adequate, the following exemplary measures could be considered in more detail in Phase 4:

- The characteristics and corresponding trip time of the protection device have a significant influence on the potential electric arc energy in the event of a fault. Replacement of the upstream circuit protector with a fast-acting safe-work fuse or the adjustment of the circuit breaker tripping characteristics during the work period might be worth considering.
- A separate electric fault arc protection device detects the arc fault via a sensor system and immediately initiates a bolted short-circuit, thereby triggering the upstream protection device. Consequently, the duration of arc combustion is reduced to just a few milliseconds. These devices may already have been considered for permanent installation during the system planning stage.
- Working distance has a significant influence on the PPEaA protection level. Therefore, it always makes sense to consider whether the working distance can be increased through the use of additional auxiliary devices.
- Short-circuit power at the workplace can be reduced by means of modified circuit variants, dependent upon the system configuration (e.g. disconnecting a mesh network switch, removing a parallel connection). It should be noted that the exposure to electric arcing must also be taken into account where it could impact the associated switching operations.
- Use tested PPEaA for higher levels of incident energy.



The following basic conditions should be considered when using PPEaA in practice:

- The requirements of DGUV Regulations 3 and 4 “Electrical Systems and Equipment” [4] must be taken into account, particularly with respect to the use of additional PPE for working on or in the vicinity of electrical installations.
- This process addresses merely that protection provided against the thermal effects of an electric fault arc. Experience has shown that these can result in the most severe consequences. Electric fault arcing in high-energy systems can lead to additional hazards, such as shock waves, acoustic shock, optical radiation or escaping electric arc gases.
- The manufacturer’s instructions must be observed to ensure the PPEaA provides the appropriate protection in the event of a fault. In particular, it is essential to adhere to the instructions for proper usage, including those specified by the manufacturer for proper care and maintenance, as well as parts replacement criteria.



#### Attention

If the risk assessment reveals that the residual risk is too high (red area) and no further measures can be implemented, then work must not be performed on the installation.

The installation must be isolated.

# Annex 1

## Directives, Regulation, Literature

### A 1.1 EU Directives and Regulations

#### Reference source:

Bundesanzeiger Verlagsgesellschaft mbH,  
(German Federal Gazette)  
Post box 10 05 34, 50445 Cologne, Germany

- [1] Regulation (EU) 2016/425 of the European Parliament and of the Council of 9 March 2016 on personal protective equipment and repealing Council Directive 89/686/EEC.

### A 1.2 Provisions, Rules and Information for occupational safety and health

#### Reference source:

Your responsible insurance provider or at  
[www.dguv.de/publikationen](http://www.dguv.de/publikationen)

- [2] German Occupational Safety and Health Act (ArbSchG)  
[3] DGUV Regulation 1 “Principles of Prevention”  
[4] DGUV Regulation 3 and 4 “Electrical Systems and Equipment”

### A 1.3 Standards/VDE provisions

#### Reference source:

Beuth-Verlag GmbH, Burggrafenstraße 6, 10787 Berlin, Germany  
VDE-Verlag, Bismarckstraße 33, 10625 Berlin, Germany

- [5] DIN EN ISO 14116: Protective clothing – Protection against heat and flame – materials, material combinations and clothing with limited flame spread (2015-11).  
[6] prENV 50354: Electrical arc test methods for material and garments used by workers at risk of exposure to electrical arcing (2000).  
[7] DIN EN 31010 (VDE 0050-1): Risk management – Risk assessment techniques (2010-11)  
[8] DIN EN 60909 (VDE 0102): Short-circuit currents in three-phase a.c. systems – Part 0: Calculation of currents (2016-12)  
[9] DIN EN 61660-1 (VDE 0102-10) Short-circuit currents – Short-circuit currents in d.c. auxiliary installations in power plants and substations – Part 1: Calculation of short-circuit currents (1998-06)  
[10] DIN EN 61482-1-1 (VDE 0682-306-1-1): Live working - Protective clothing against the thermal hazards of an electric arc – Part 1-1: Test methods – Method 1: Determination of the arc rating (ELIM, ATPV and/or EBT) of clothing materials and of protective clothing using an open arc (2020-08).  
[11] DIN EN 61482-1-2 (VDE 0682-306-1-2): Live working – Protective clothing against the thermal hazards of an electric arc – Part 1-2: Test methods – Method 2: Determination of Arc protection class of material and clothing by using a constrained and directed arc (box test)  
[12] IEC 61482-2: Live working - Protective clothing against the thermal hazards of an electric arc – Part 2: Requirements (2018-05).  
[13] RfU CNB/P/03.024: RECOMMENDATION FOR USE “Eye and face protection against electrical arc; additional requirements” (2013-03)  
[14] NFPA 70E: Standard for Electrical Safety in the Workplace (2018).  
[15] IEEE 1584: Guide for performing arc-flash hazard calculations (2018).  
[16] ASTM F2178 – 12: Standard Test Method for Determining the Arc Rating and Standard Specification for Face Protective Products  
[17] ASTM F2178 – 17b: Standard Test Method for Determining the Arc Rating and Standard Specification for Eye or Face Protective Products  
[18] ASTM F2675/F2675M – 13: Standard Test Method for Determining Arc Ratings of Hand Protective Products Developed and Used for Electrical Arc Flash Protection  
[19] IEC 63232-1-1 ED1 Live Working – Hand Protective Devices Against the Thermal Hazards of an Electric ARC – Part 1-1: Test methods – Method 1: Determination of the arc rating (ELIM, ATPV and/or EBT) of hand protective devices using an open arc; CD 2020  
[20] IEC 63232-1-1 ED1 Live Working – Hand Protective Devices Against the Thermal Hazards of an Electric ARC – Part 1-1: Test methods – Method 2: Determination of arc protection class hand protective devices by using a constrained and directed arc (box test); CD 2020

## A 1.4 Literature

- [21] Schau, H.; Halinka A.; Winkler, W.: Elektrische Schutzeinrichtungen in Industrienetzen und -anlagen Hüthig & Pflaum Verlag München/ Heidelberg 2008.
- [22] Schau, H.: Schutzausrüstung gegen Störlichtbögen auswählen. Schutz von Personen vor Störlichtbögen. Elektropraktiker, Berlin 69 (2015) 1, Pg. 44–51
- [23] GS-ET-29, Supplemental requirements for the testing and certification of electrician face shields, status as of 2010-02, Expert committee for electrical engineering testing and certification facility in DGUV Test, [www.bgetem.de](http://www.bgetem.de), Webcode: pruefstelle-et.
- [24] GS-ET-42-1, Supplemental requirements for the testing and certification of electrically insulating gloves with additional protection against the thermal effects of electric fault arcs, Status as of 2019-02, Expert committee for electrical engineering testing and certification facility in DGUV Test, [www.bgetem.de](http://www.bgetem.de), Webcode: pruefstelle-et
- [25] GS-ET-42-2, Supplemental requirements for the testing and certification of heat-protective gloves with additional protection against the thermal effects of electric fault arcs, Status as of 2019-02, Expert committee for electrical engineering testing and certification facility in DGUV Test, [www.bgetem.de](http://www.bgetem.de) Webcode: pruefstelle-et
- [26] IVSS Guideline for the selection of personal protective equipment when exposed to the thermal effects of an electric fault arc (2nd edition 2011)
- [27] Feasibility study related to the testing and evaluation of protective gloves against the thermal hazards of electric fault arcing. Feasibility study in German – (AG: BGFE; AN: STFI/TU Ilmenau), STFI final report from 30 May 2005
- [28] Literature reference to lectures held by the BG ETEM Dept. of Electrical Engineering in 2018

Further literature references are made available on a continuing basis. These are available on the Internet website of the Subcommittee Electrical Engineering and Precision Mechanics of the DGUV Department of the Expert Committee Energy Textile Electrical Media Products (ETEM) of DGUV ([www.dguv.de](http://www.dguv.de); Webcode: d1183022).



# Annex 2

## Standardization of PPEaA against the thermal effects of electric fault arcing

### A 2.1 Standardization for protective clothing

The testing and evaluation of potentially life-saving clothing in the event of a hazardous incident is addressed in the standard, IEC 61482-2 [12], which establishes the requirements for protective clothing and materials used to protect against the thermal effects of electric fault arcing. This standard requires that testing must be performed on all clothing and materials under electric fault arc conditions. In addition, two normative testing methods have been specified at the international level.

### A 2.2 Standards originating in Europe for testing protective clothing

The testing of PPEaA related to electric arcing began in Europe in the 1990s with an extensive examination of the potential protective properties of flame-resistant textiles against the thermal effects of electric fault arcing.

The standardization process was initiated with the goal of safely and reproducibly testing and evaluating the clothes used for protecting against the effects of electric arcing. Testing began with textile surfaces and products in two Arc protection classes on the basis of a draft standard available at the time: prENV 50354 [6] (Electrical arc test methods for material and garments used by workers at risk of exposure to electrical arcing), to determine the effectiveness of the protection provided. This method

employed a box with one side open for generating a directed electric arc exposure at a test specimen, textile surface or jacket positioned at a distance of 300 mm.

This draft also defined the use of aluminium and copper electrodes in order to simulate real conditions as consistently as possible. The assessment criteria stipulated:

- no specimen after-flame time > 5 s
- no hole formation > 5 mm
- no melting through to the inside,
- functionality of the garment closure system following exposure.

The method's greatest disadvantage, however, was it lacked the goal of stipulating actual protection levels against the thermal effects of electric fault arcing. As can be seen from the assessment criteria, the methodology merely confirms that it is not anticipated that the bearer of the clothing will suffer injury due to its penetration during an electric arc occurrence (e.g. due to burning, hole formation, etc.). To that effect, it was also not possible to assess the risk of skin burn, as could be experienced if protective clothing with inadequate thermal insulation was worn.

Nevertheless, these safety-relevant gaps in the testing and evaluation of protective clothing against the thermal hazards associated with electric fault arcing were eventually filled with the internationally harmonized standard IEC 61482-1-2. This test standard was also published as DIN EN 61482-1-2 (VDE 0682-306-1-2) [11] and successfully revised for the first time in 2014. As a consequence of advancing the idea of directed electric arc testing using a test box opened only in the direction of the specimen, this standard comprises the testing of surface materials and products for two protection classes, distinguished by respective levels of electric arc energy and incident energy.

Table A 2-1 below provides an overview of the relevant parameters for each test category.



Fig. A 2-1 Test setup, Box test method

**Table A 2-1** Box test method parameters

Arc protection class	Mean value of electric arc energy $W_{arc}$ [kJ]	Mean value of incident energy [kJ/m <sup>2</sup> ]	Prospective test current [kA]	Arc time [ms]
APC 1	168	146	4	500
APC 2	320	427	7	500

The basic philosophy of this methodology comprises the objective testing and evaluation of the protection afforded by flame-resistant materials or material combinations against electric fault arcing, as well as verification of the protection afforded by the finished product. Both the material specimens and products are positioned at a distance of 300mm to the electric arc axis, which corresponds to a conceivable working distance under realistic working conditions. The electric arc axis is defined by the two vertical electrodes positioned at a distance of 30 mm apart from each other. The electrode material is comprised of aluminium (upper) and copper (lower) in order to replicate practical system conditions as closely as possible. The desired focusing of the extreme thermal effects associated with electric arc exposure is realized through the parabolic form of the test box, which surrounds the electrode array on three sides. The upper and lower sections of the plaster box construction are sealed by means of insulating boards. Corresponding to the test current used for the respective Arc protection class, an arc flash is ignited in a 400 V AC test circuit and extinguished after a combustion duration of 500 ms.

The Box test method features a high degree of reproducibility. Within the context of revising the test standard, comparative testing was conducted and evaluated on the basis of ISO 5725-2, with the participation of four test laboratories in Italy, Spain and Germany. Standard deviations were determined for the material testing method, including the repeatability within a laboratory  $s_R$  and the reproducibility  $s_R$  of the method (reproducibility or total deviation), depicted in Table A 2-2 below.

The parameters evaluated are the control variables for electric arc energy  $W_{arc, test}$  and direct incident energy  $E_{i0P}$ , as well as for the difference  $E_{it} - E_{iSTOLL}$ , which characterizes the quantitative test criterion for transmitted incident energy  $E_{it}$  (with relation to the threshold value  $E_{iSTOLL}$  for

the onset of 2nd degree skin burns, accompanied by blistering of the skin with or without scarring).

For the reproducibility of the control variables, the standard deviation resulted in less than 5.3 % for electric arc energy and less than 11 % for incident energy, which is considered very good in light of the stochastics of the electric fault arc occurrence.

The Box test method setup utilizes a test plate for mounting the textile specimens, and on which two calorimeters are integrated for measuring transmitted incident energy. This enables measurement of the heat transfer to the skin surface (back side of sample) and, in so doing, allows for conclusions to be drawn as to the risk of 2nd degree burning with comparison to the limit values associated with the Stoll/Chianta criterion. In addition, a visual assessment is made of each specimen based on criteria related to after-flame time, hole formation and melting through to the inside. Finished products, such as jackets, overcoats, parkas, etc., are tested on a standardized mannequin. Besides the visual evaluation criteria analogous to a surface inspection, an additional functional test is performed on the garment closure system. This is required because only a functioning closure system enables the quickest possible removal of garments in the event of an electric arc accident. Moreover, testing the finished product also serves as a test of other accessories, such as reflective strips, logos or emblems with respect to their resistance to electric arcing.

This testing standard has been well-established for years and serves as the certification basis for numerous clothing articles used to protect against electric arcing within the territory covered by Europe's mandatory Regulation (EU) 2016/425 relating to personal protective equipment (previously Directive 89/686/EEC) [1].

**Table A 2-2** Evaluation of the comparative test

Parameters		Arc protection class (APC)	Repeatability $S_r$	Reproducibility $S_R$
$W_{arc, test}$		1	3.5 kJ	5.0 kJ
		2	4.0 kJ	17.1 kJ
$E_{iOP}$ (Calibration test)		1	15.7 kJ/m <sup>2</sup>	16.0 kJ/m <sup>2</sup>
		2	22.8 kJ/m <sup>2</sup>	31.1 kJ/m <sup>2</sup>
$E_{it} - E_{iStoll}$	Material test, 2 Materials	1	10.2 kJ/m <sup>2</sup>	12.0 kJ/m <sup>2</sup>
	Material test, 1 Material *	2	14.5 kJ/m <sup>2</sup>	14.5 kJ/m <sup>2</sup>

\* 2. Material cannot be evaluated

New findings reveal that the Arc protection classes also describe the effects of energetic exposure in adequate DC systems.

### A 2.3 Standards originating in America for testing protective clothing

Outside Europe, another test method is primarily used for assessment of arc flash protection. Determination of the arc rating ATPV (Arc Thermal Performance Value) in accordance with IEC 61482-1-1 is a dominant feature here. This methodology, also published as DIN EN 61482-1-1 (VDE 0682-306-1-1) [10], requires a medium voltage source and is based on an open, undirected electric arc with exposure of three material samples arranged respectively in a circular manner (120° offset). The textile specimens are affixed to panels, on which two calorimeters are installed for measuring transmitted incident energy.

Each panel is additionally outfitted with two unprotected calorimeters mounted on the left and right sides of the specimen, which simultaneously register the direct incident energy. The centre of the circle is formed by 2 stainless steel electrodes at a distance of 300 mm to each panel (electrode gap 300 mm). As opposed to the Box test method, IEC 61482-1-1 does not specify a defined class of protection. With a test current of 8 kA and variations in the arc duration, the method determines the respective arc rating (ATPV or EBT) for each flame-resistant material



Fig. A 2-2 ATPV Test setup

from at least 20 individual values using a logistical regression method. This rating represents the degree of energy acting on the material, which would lead to a 50 % probability of exceeding the Stoll threshold value (ATPV) or to a breakup of the material down to the body surface (EBT).

Assessment criteria for each individual test sample are:

- hole formation/breakup of the material in all layers,
- heat transfer exceeding the threshold value for skin burn (Stoll curve).

After determining the rating for the material, the product is subjected to durability testing using the same arc duration and a mounted mannequin instead of panel mounting.

Users must be able to safely and successfully apply the risk assessment and risk estimation methodology in order to make the right choice of clothing appropriate for the arc rating. Otherwise, the rated value will not suffice for recommending a selection for work on or in the vicinity of electrical equipment. Examples for the risk assessment and risk estimation methodology can be found in NFPA 70E (Standard for Electrical Safety in the Workplace) [14] or IEEE 1584 (Guide for performing arc-flash hazard calculations) [15].

Similarly, there are no sure options to date for assessing the comparability between the ATPV value and the Box test method used primarily in Europe for testing and certifying protective clothing according to IEC 61482-1-2.

The methodology according to IEC 61482-1-1 was revised and appeared in a 2nd Edition in June 2019. In Germany, this standard was published as DIN EN 61482-1-1 (VDE 0682-306-1-1:2020-08) [10]. In addition to a multitude of technical clarifications and changes, the 2nd Edition is largely characterized by the introduction of a further parameter, ELIM (Energy limit). Besides the known values ATPV and EBT, this new parameter should solve the 50 % probability problem of exceeding the threshold value of thermal transmitted incident energy. This is realized in that the result only considers the average value of the three measured values directly beneath the transition range, designated as the mix zone.

Yet, the criteria for assessing the material using electric arc test shots, particularly with respect to the after-flame time and hole formation, is significantly different from the Box test method. For this reason, even the revised version of IEC 61482-1-1 does not include a limit for the after-flame time on materials that have ignited due to electric arc exposure. While the Box test sets clear limits on the maximum after-flame time of 5 s for material properties under evaluation and deemed critical, an equivalent determination is not found in IEC 61482-1-1. Even the definition of a hole (material breakup through all layers) at 25 mm is five times larger than in the Box test. This clearly shows the contrast between the European approach to testing and evaluation standards developed for legally stipulated PPE (according to the PPE Regulation) and the primarily American-dominated approach to electric arc testing and evaluation.

## A 2.4 Standardization for other types of PPEa

Experts from national and international standardization bodies are working to standardize further types of PPEa, focusing particularly on protective equipment for the head, face, eyes and hands. The common element among these efforts is that they are largely based on existing, internationally standardized test specifications for protective clothing using the Box Test or the Open Arc Test. To a great extent, a complete selection of protective equipment is available to the user today, whose arc flash protection properties have been tested and evaluated according to the same basic principles.

### A 2.4.1 Standards originating in Europe

#### A 2.4.1.1 Head, eye and face protection

The basic European standard for eye and face protection is EN 166. In Section 7.2.7 “Protection against electric arcing”, however, the only requirements described therein have been derived from a series of tests where different materials are exposed to electric fault arcing and then visually inspected. It was presumed that PPEa for the eyes and face that did not melt, burn or show any other signs of serious damage when exposed to electric fault arc testing, would also protect the wearer of this PPEa. Yet, subsequent testing using sensors mounted behind the respective face shield revealed that this assumption was not justified. This is because, depending on the material and the design of the face shield components, and without additional testing, it cannot be ruled out that radiation could penetrate the optical component of the PPEa for the eyes and face without causing relevant damage to the PPE itself, or that the arc energy could cause damage to the eyes or face from the side of, or from beneath the PPEa.

For this reason. The Electrical engineering testing and certification facility in DGUV Test has developed the GS-ET-29 Principles of testing [23], which address all thermal-related hazards associated with electric fault arcing, as well as further occupational safety-relevant requirements, such as light transmittance. The test setup according to IEC 61482-1-2 was adopted for the electric fault arc testing described herein, using sensors set into a specially developed test head, two of which are at eye level, one at mouth level and one under the chin of the test head.

This test head is mounted onto a vertically arranged plate in such a manner that the mouth sensor is located at the height of the electric arc concentration.

The Supplemental requirements for the testing and certification of electrician face shields, integrated into these Principles of testing, have been mandatory for products certified in Europe since 2013 (refer to 'Recommendation for Use' RfU 'CNB/P/03.024' [13]). This ensures that, despite the prevailing absence of harmonized standards in Europe, certified products will have actually demonstrated both a resistance to, as well as protection against electric arcing.

Electric arc testing of the face shield is considered to have been passed when an after-flame time  $\leq 5$  s, no melting through of the test objects and no appearance of hole formation has been demonstrated on four test specimens. At the same time, the value pairs of all test head calorimeters must lie below the defined threshold values for the risk of skin burn according to the Stoll/Chianta criterion over the entire measuring period of 30 s.

EN 166 and its subordinate standards will be superseded in the near future by the international standards, ISO 16321-1, ISO 16321-2 and ISO 16321-3, which, however, no longer include specific requirements for protection against electric arcing. Nevertheless, parallel to these standards, IEC 62819 (VDE 0682-341) does comprise international requirements and testing standards specifically addressing the protection of the head, eyes and face against the thermal, optical and mechanical hazards associated with electric fault arcs. Besides the fundamental requirements therein, placed on all protective equipment for the eyes and face, special requirements will specify the thermal, optical and mechanical protective properties of PPEaA for the eyes and face while describing appropriate testing methods, or will reference the corresponding testing methods in accordance with ISO 16321-1 and ISO 16321-2.

Just as for eye and face protection the test standard GS-ET-29 [23] is the box test counterpart of the arc fault test standard IEC 61482-1-2, the North American test method ASTM F2178 [16] is the counterpart of IEC 61482-1-1 for determining ATPV, or EBT. Both methods are described in the international version of IEC 62819, but because of the 50 % probability of 2nd degree burns tolerated when

determining the ATPV, it is likely that only ELIM, also described therein, will be used along with the Box test method in the harmonized EU version.

#### A 2.4.1.2 Hand protection

There is also an absence of harmonized standards for testing and evaluating protective gloves for resistance to, and protection against electric arcing. For this reason, the Department of Electrical engineering testing and certification facility, ETEM in DGUV Test has pursued the development of the Principles of testing GS-ET-42-1 "Supplemental requirements for the testing and certification of electrically insulating gloves with additional protection against the thermal effects of electric fault arcs" [24] and GS-ET-42-2 "Supplemental requirements for the testing and certification of heat-protective gloves used to protect against the thermal effects of electric fault arcs" [25] based on an earlier research project [27].

These test specifications have been available since February 2019 and comprise not only the testing of resistance to, and protection against electric arcing, but also further safety-relevant supplemental requirements for acceptable electric arc protective gloves. It uses the basic system conditions for directed exposure with the Box test method according to IEC 61482-1-2 while using specimen holders designed especially for gloves. Three semi-circular configured panels equal distance from the test box, each of which being outfitted with horizontally and vertically oriented calorimeters centred at the middle of the electric arc axis, facilitate testing of complete gloves.

Besides the testing of clothing for Arc protection classes APC 1 and APC 2, two additional tests for Arc protection classes APC 1\_150 and APC 2\_150 are possible. These contribute to the assessment of the product with a significantly higher degree of direct incident energy, which appears justifiable for gloves, if only on the basis of the anticipated short distance to the fault source. These additional test categories are achieved by reducing the distance between the specimen and the electric arc by 50 % (150 instead of 300 mm) while using the corresponding Arc protection classes APC 1 or APC 2 electric arc energy levels (168 or 320 kJ).

This application is not limited to electrically insulating gloves. GS-ET-42-2 also provides important safety-rele-



vant information for other types of gloves, such as leather gloves. Yet, good thermal protection is important for effective PPEa, which is why these gloves must fulfil the basic requirements of DIN EN 407 “Protective gloves against thermal risks (heat and/or fire)”.

Not only is the burning behaviour of the material tested, but also the thermal stability of the seams with direct flame exposure (seam opening). With respect to arc flash protection, the test method calls for the testing at least three pairs of gloves (6 individual test objects). Subsequent to electric arc exposure, none of the specimens may exhibit an after-flame time > 5 s, melting through to the inside, hole formation or exceed the threshold values for skin burns according to the Stoll/Chianta criterion.

Under these conditions, one can assume the protective gloves have been tested and evaluated according to latest knowledge available.

At the end of 2018 on the basis of this work, it was resolved at an international level to form a project group for developing testing standards for all forms of protective equipment for hands (e.g. gloves, gauntlets, etc.) against the thermal hazards of electric fault arcing. Under the designation IEC 63232-1-2 [20], an international test standard based on the Box test will be published in the coming years, which will go beyond clothing and head, eye and face protection to encompass complete personal protection in the area of the hands.

#### A 2.4.2 Standards originating outside the EU

International non-harmonized test and evaluation options are also available for supplementary protective equipment for clothing tested according to ATPV arc rating described in IEC 61482-1-1.

Head and face protection can be tested according to the ASTM F2178 – 17b [17] standard, which was published only in the USA. This methodology uses systems engineering for determining the ATPV for textiles, whereby the test specimens, including helmet and visor, are affixed to a test head outfitted with four calorimeters. They are then attached to a mannequin similar to those used for durability testing of clothing, with the calorimeter, aligned horizontally and vertically centred opposite the middle of the electric arc axis, positioned in the facial area of the

head. Analogous to the textile testing, measurements are made of the direct incident energy at the unprotected calorimeter on the side of the head for every test cycle. The arc rating is calculated step-by-step in conjunction with the measured transmitted incident energy.

The existing standard for testing and evaluation of gloves, published only in America, is ASTM F2675/ F2675M – 13 [18]. This concept calls for a ring-shaped setup with a quarter-circle opening, on which four panels are located for affixing the test specimen. Each glove panel is out-fitted with a calorimeter, whose alignment is horizontally and vertically centred at the middle of the electric arc axis and is used for measuring the transmitted incident energy. Two unprotected calorimeters are arranged on the sides of the panels serve to determine direct incident energy for each individual test cycle, similar to the textile testing. Determination of the ATPV arc rating then takes place analogous to the methodology already described. The standardization work for the arc rating of equipment to protect hands (gloves, gauntlets, etc.) against the thermal hazards associated with electric fault arcing has been under way at the international level since the end of 2018 within the IEC 63232-1-1 project group [19].

Nevertheless, the same restrictions apply to the arc rating determined for face shields and gloves as for clothing. Its use requires experience in the application of American directives related to the assessment of electric fault arc risks at the workplace.

## A 2.5 Requirements for proper selection

When considering satisfactory arc flash protection, one must always bear in mind the overall potential thermal risk to the head, the face and the torso, as well as the extremities out to the hands, generated by an arc flash. Even though international efforts have still not achieved the same standards for all these areas, the different types of PPEa must always be viewed as an overall system when properly selected and matched to one another.

The outfits used for protection against electric arcing are high-tech products, oftentimes providing multifunctional protection. For this reason, respective electric arc resistance testing is not sufficient in itself when selecting such PPEa. Much more, it must be recognized and kept in mind that not one of the methods described to date is capable of reproducing the overall demands to which such PPEa would be subjected.

All of the standards mentioned to this point are merely test standards, which may confirm the most essential characteristics, but still not all those required of safe PPEa. In an emergency situation, for example, an inner lining made of non-flame-resistant material or a seam made of 100 % polyester thread can severely injure the wearer. Likewise, with too little transmission resistance, such as when surface conductive fibres are used to enhance the clothing's electrostatic dissipation properties, the protection against contact with live parts may not exist under certain circumstances, and further secondary hazards may even arise. High concentrations of CO<sub>2</sub> can be detected in closed hoods without ventilation after only relatively short wearing periods, which, in turn, can impact concentration levels and could even lead to a loss of consciousness. The optical quality of the viewing panel on the visor and freedom of movement for the head must be considered. An unobstructed downward field of vision will prevent tripping, etc.

Moreover, the classic textile-specific requirements, such as dimensional stability when washing, maximum firmness and resistance to tear propagation are not only quality-relevant to the user, but safety-relevant as well. Finally, only the use of suitable and appropriately tested accessories, such as flame-resistant reflective strips, emblems or logos, will prevent any negative influence these might have on an article of clothing's protective function. In or-

der to achieve a satisfactory degree of safety for the potential user, both the manufacturer and the responsible certification body must have taken these risks into account and eliminated them to the greatest extent possible by specifying suitable materials and appropriate designs.

The international standard, IEC 61482-2 [12] is presently regarded as providing the best method for comprehensively testing and evaluating clothing used for protection against electric arcing.

An essential component of this product standard is the verification of arc protection properties through the textile materials employed, as can be rendered in accordance with DIN EN 61482-1-2 (VDE 0682-306-1-2) [11].

A decisive basic requirement is the exclusive use of flame-resistant raw materials (Index 3 according to DIN EN ISO 14116 [5]) for the outer and, if applicable, for the inner clothing layers. The typical demands placed on protective clothing, emphasizing dimensional stability and mechanical wear durability, as well as the minimum requirements for maximum tensile strength and tear propagation resistance, supplement the material-specific requirement profile.

IEC 61482-2 [12] also regulates the important safety-relevant requirements related to design of the clothing, itself. Perhaps due to reasons of wearing comfort, different Arc protection classes selected for the front and back areas are also clearly regulated, such as with the exclusive use of flame-resistant sewing thread for all main seams. If special design requirements have been considered in addition to the standard, such as sealable pockets to protect against extensive molten metal splatter in case of fault, then the user can be assured of wearing comprehensively tested and evaluated clothing to protect against the thermal risks of an electric arc accident.

This also applies for the respective trousers or overalls as part of a complete protective outfit. Although the methods introduced were originally and are primarily intended for the testing of ready-made jackets, shirts, parkas and the like, the certifying bodies will also intensively evaluate pants for their protective properties. For this, the use of identical raw materials for pants and jackets, as well as the implementation of the design stipulations adopted in IEC 61482-2 [12] will be decisive. If, as a result of a risk assessment, the user determines that complete protec-

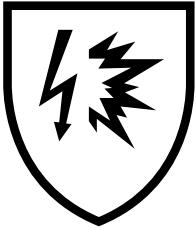

Fig. A 2-3  
Pictogram IEC 60417-6353 for marking electric arc tested PPEa  
[Copyright © 2016 IEC Geneva, Switzerland. [www.iec.ch](http://www.iec.ch)]<sup>1</sup>

tive suit or overalls can be dispensed with, then the pants selected separately from the arc rated jacket must be tested for suitability by the user himself. In order to avoid uncertainties and possible risks, it is recommended to select a complete outfit made up of a jacket and pants.

For especially hazardous areas with a very high degree of electric arc energy, or where an especially high level of wearing comfort is desired, clothing concepts that provide arc flash protection through a combination of multiple layers of clothing articles, such as jackets and shirts, may prove suitable. This “onion peel” principle derived from sports, recreation and outdoor activities, can also make a valuable contribution to the protection and safety afforded by PPEa. Collaboration with a responsible and experienced supplier can lead to optimal design concepts that oftentimes provide significant added value when compared to the classic standard solutions. Essential requirements for this, however, are that the materials used for the individual parts of the clothing, as well as for the clothing articles, themselves, are suitably tested, are certified together and, of course, are worn.

It must be noted that the harmonized standard DIN EN 61482-2 will also be available shortly. In order to achieve this, the pending publication of the 2nd Edition of test standard DIN EN 61482-1-1 must be realized (refer to A 2.2), because this standard includes the ELIM parameters for the first time. This will solve the problem of the 50% probability of exceeding the Stoll/Chianta criterion, which represents a prerequisite for the presumption of conformity



Fig. A 2-4  
Protective gloves identified with electric arc tested PPEa markings

in EN 61482-2 regarding PPE Regulation (EU) 2016/425. The standard EN 61482-2 came out in May 2020 and is based on IEC 61482-2: 2018 with the relevant modifications (IEC 61482-2:2018, modified).

For as comprehensive arc flash protection as possible, the user should also ensure that the manufacturer confirms compliance with IEC 61482-2 [12] and did not merely carry out testing on the material or the product. From May 2018, this must be made evident according to the 2nd Edition of IEC 61482-2 through a new Pictogram for PPEa on the label (refer to Fig. A 2-3).

The same symbol can also be found on the marking (label) on electric arc protective gloves, which have been tested and certified according to GS-ET-42-1/-2. This gives the user the guarantee that these can be selected as an integral part of a holistic approach towards protection and can be used for their intended purpose.

The greatest challenge remaining is to define, and to choose the respective test category (Arc protection class APC 1, 2, 1\_150 or 2\_150), which the gloves will have to have passed. In this context, the user should not only consider the Arc protection class determined for the protective clothing (APC 1 or APC 2) when selecting PPEa. Equal attention should also be placed on the risk-influencing ergonomic properties because, particularly with protective gloves in higher test categories, restrictions on the tactile attributes (agility) must be expected.

<sup>1</sup> “The author thanks the International Electrotechnical Commission (IEC) for permission to reproduce Information from its International Standard. All such extracts are copyright of IEC, Geneva, Switzerland. All rights reserved. Further information on the IEC is available from [www.iec.ch](http://www.iec.ch). IEC has no responsibility for the placement and context in which the extracts and contents are reproduced by the author, nor is IEC in any way responsible for the other content or accuracy therein”.



Fig. A 2-5 Head and face protection

Comprehensive arc flash protection is considered complete when tested and certified head and face protection is selected and worn in accordance with GS-ET-29 [23] (also refer to A 2.4.1.1). These products, as well, can be recognized by the electric arc tested PPEaA pictogram, which guarantees the wearer overall protection and safety from head to toe.

# Annex 3

## Parameters and risk analysis of thermal hazards to persons due to electric arcing

### A 3.1 General Preliminary remarks

The assertions made in this Annex are tailored for three-phase AC systems. At the same time, the assertions also apply in a figurative sense to DC systems, which will be addressed in the conclusion of the respective section.

### A 3.2 Energetic parameters for thermal hazards to persons due to electric arcing

The electrical energy fed into an electric fault arc is almost completely converted therein and emitted or released back in various forms. For this reason, the impact of electric arcing is primarily determined by the electric arc energy  $W_{\text{arc}}$ . Electric arc energy clearly identifies the relationships associated with system short-circuit-related arcing. Different network and system conditions will result in different electric arc energies.

The significant level of exposure or risk a person is subjected to as a result of thermal influences is the energy density impacting the exposed surface of the skin. This is the incident energy  $E_i$  that is present as direct incident energy  $E_{i0}$  with the thermal impact of a proximate electric arc. If the person is wearing PPEaA, then the incident energy should be considered as transmitted incident energy  $E_{it}$ . In the testing of PPEaA, a determination is made as to whether the transmitted incident energy will exceed the limits for an onset of 2nd degree skin burns (Stoll/Chianta criterion). A successful test will verify that the PPEaA is arc-resistant and provides protection up to the level of direct incident energy as per the test settings.

There is a complicated non-linear correlation between electric arc energy and direct incident energy, which is determined through the specific transmission and exposure relationships, including system configuration and the effective distance between the arc flash and the person (transfer relationship). The transmission and exposure conditions related to thermal influences can be very diverse. A Risk assessment must include or address all related cases and requires a “worst-case” examination.

The correlation between electric arc energy and direct incident energy is known for both Arc protection classes

for the Box test of PPEaA (protective textiles and clothing) according to DIN EN 61482-1-2 (VDE 0682-306-1-2) [11]. These are control parameters for the test settings and characterize the transfer relationships for the test setup.

During the Box test, the effects of radiation (including reflections) exist, particularly as a result of arc flash directivity (gas flow) resulting from the small-scale box structure and through “worst-case” transfer conditions influenced by the electrode materials. Comparable examinations with other configurations reveal that, with the same electric arc energy being fed into the Box test structure, the highest level of thermal incident energy results.

### A 3.3 Methods for determining $W_{\text{arc}}$ and $W_{\text{arc, prot}}$

The electric arc energy  $W_{\text{arc}}$  to be expected within the scope of application can be determined using the methods described below. The maximum value of expected electric arc energy will be ascertained and is measured in kJ. Based on this, it must then be verified that the maximum occurring exposure (thermal impact) will not exceed the level of protection and strength afforded by the PPEaA. The related parameter is then the electric arc energy for the test category being examined in the Box test – the test level. The level of equivalent arc energy for the PPE test must meet this level. For specific applications, existing deviations from the distance, geometry and test transmission relationships can be accounted for when determining equivalent arc energy, the protection level  $W_{\text{arc, prot}}$ .

The relationship to the expected value of electric arc energy must be accounted for on the basis of the test level (equivalent arc energy) when selecting the test category or the Arc protection class of the PPEaA.

The thermal hazards associated with electric fault arching are deemed to have been met if

$$W_{\text{arc}} \leq W_{\text{arc, prot}} \text{ applies.}$$

The test currents for the test categories from the Box test do not correspond with the PPEaA application limits with respect to short-circuit current levels.

The risk analysis is comprised of the following work steps:

- Determination of the expected electric arc energy value,
- Examination of the arc protection level of the PPEaA,
- Consideration of divergent exposure conditions.

Comprised in the work steps are the determinations below for the workstation or area being analysed:

- Nominal voltage or stipulated network voltage.
- Prospective (bolted) short-circuit current (AC: initial short-circuit current or DC: sustained short-circuit current).
- The  $R/X$ -ratio for the network or the short-circuit electrical circuit impedance (AC) or the ohmic resistance  $R$  and the inductance  $L$  of the electrical circuit (DC).
- Installation geometry (electrode gaps and volume relationships at potential fault locations)
- Working distances (potential electric fault arc onset and combustive locations, minimal effective distances to the arc flash).
- Type, model, settings and characteristics of the protection device(s) (circuit breakers, fuses or other special protection devices upstream from the work area).
- Protection level of the PPEaA test category.

*Note:*

*It should be pointed out that the different switching states of the distribution network or energy supply system can lead to different short-circuit power readings and energy levels. For this reason, it may be necessary to analyse a number of such cases in an installation, and then to investigate the specific case where greatest arc flash hazard exists.*

Analysis of the energy supply system must encompass all work areas, which generally comprises the point of supply to the network in question up to the user outlet.

## A 3.4 Work steps

Under A 3.4, observations are described for AC and three-phase AC systems that can essentially be applied to DC systems, as well. The particular aspects of DC systems will be addressed in Sections A 3.4.3.1, A 3.4.4.1, A 3.4.6.1 and A 3.4.7.1.

### A 3.4.1 Ascertain the general operating conditions

The starting point for the analysis is to consider the general operating conditions. An initial list should be compiled that includes network voltage levels, network equipment types and locations, as well as the work tasks involved.

*Note:*

*It must be kept in mind throughout the process that differing prospective short-circuit current readings can result from the different network switching states and upstream supply systems. Short-circuit current is greatest when the network junction (switchgear bus bar or distributor) is supplied through multiple feed inputs or transformers. Differing short-circuit current values with different switching states in the same system must nevertheless be accounted for, because the electric arc energy at lower short-circuit current levels may definitely be greater than at the higher current levels due to the longer overcurrent protection fuse trip times.*

With respect to work activities (electrotechnical work, switching operations), all tasks that are executed on open electrical installations or that call for equipment to be opened (work performed in the vicinity of live components or live working) will play a role.

*Note:*

*In the case of construction-type tested switchgear for which the test validation of arc resistance is available (Medium voltage: Electric arc testing according to DIN EN 62271-200, Low voltage: electric arc testing criterion 1–5 according to EN 61439-2, Supplement 1), personal protection can always be assumed when operating or performing work tasks on a closed system. This does not need to be incorporated into the further analysis. On non-tested systems, it must not be assumed that the system will remain closed in the event of an internal arcing fault and/or that the effects of inadmissible electric arcing will not occur outside the system (e.g. due to*

escaping hot gases, bursting parts, etc.); this situation must be treated as in the case of an opened system or the hazardous situation must be considered separately.

#### A 3.4.2 Calculate the short-circuit currents at the work places under study

A prerequisite for the risk analysis and the selection of PPEaA is to be aware of the prospective short-circuit current or short-circuit power associated with the equipment (or network junctions) that will potentially be worked on.

*Note:*

*As a rule, the risk analysis should be undertaken for different workstations in a network or supply system. In larger systems, it is often advisable to develop and observe identical structures and parameters or similar basic electrical configurations (circuits).*

The calculation of short-circuit current is to be performed according to the standard methodology described in DIN EN 60909-0 (VDE 0102) [8] or DIN EN 61660-1 (VDE 0102-10) [9]. Calculation software is usually available for this process.

In three-phase AC systems, the maximum and the minimum prospective 3-pole initial short-circuit AC currents  $I''_{k3,max}$  and  $I''_{k3,min}$  are to be determined for each workstation/equipment area for the possible/relevant network switching states. Standard determinations are made of these currents for bolted, zero impedance short-circuits (impedance at the fault location is zero). Information regarding short-circuit currents or short-circuit power can also be obtained through the power supply network operator. It is important to ensure that the short-circuit currents apply to the fault location corresponding to the work location under consideration.

*Note:*

*If only the short-circuit current (or short-circuit power) is provided at the supplying step-down transformer by the low voltage network operator, then the short-circuit current for the work locations (fault locations) remotely located from the transformer in the low voltage network must be calculated from medium voltage to low voltage*

*on the basis of the supply transformer technical specifications, while accounting for the low voltage cable types and lengths used. If applicable, a multi-source feed to the fault location must also be accounted for.*

In the event of an actual short-circuit (with arc flashing), reduced current will flow as a result of the electric arcing (fault point impedances) - the electric arc short-circuit current (fault current due to an electric arc short-circuit).

If software is available that can be used for determining the short-circuit current associated with an electric arc short-circuit  $I_{k,arc}$ , then this current should also be determined for the relevant switching states.

Electric arc short-circuit current can be calculated on the basis of  $I''_{k3,min}$  with the help of a current limiting factor  $k_B$ . The following applies

$$I_{k,arc} = k_B \cdot I''_{k3,min}$$

Factor  $k_B$  is determined on the basis of the arc voltage  $U_{arc}$  dependent on the nominal network voltage  $U_{Nn}$ , the  $R/X$  ratio of the short-circuit electrical circuit impedance and the electrode gap  $d$  (distance between adjoining conductors in the electrical system).

*Note:*

*The reduction or limitation of the fault current resulting from an electric fault arc at the fault location plays a practical role only in low voltage systems. The current limitations for medium voltage or high voltage networks can be ignored ( $k_B = 1$ ).*

##### A 3.4.2.1 Particular aspects of short-circuit current calculations for DC systems

The prospective short-circuit current  $I_{kDC}$  (bolted short-circuit) must be determined in DC systems. The electric arc short-circuit current is determined iteratively.

#### A 3.4.3 Determine the short-circuit duration (arc duration)

The arc duration  $t_{arc}$  or short-circuit duration  $t_k$  is an essential parameter and will be required for the risk analysis. It is determined by the overcurrent protection device and generally can be taken from the selectivity calculations and/or trip time characteristic curves (current-time

curves) provided by the overcurrent protective device manufacturer.

With current-time dependent overcurrent protection fuses, such as a fuse, it must be considered that the trip time will be influenced by the level of the actual short-circuit current and, thereby, from the current limitation through the electric fault arc, itself.

The actual short-circuit current in the low voltage range does not correspond to the prospective short-circuit current, but to the electric arc short-circuit current  $I_{k, arc}$  and can be significantly limited. The actual short-circuit current  $I_{k, arc}$  can only be determined by approximation with consideration given to a number of influencing variables and is subject to a degree of uncertainty (refer to A 3.4.2).

One is generally considered to be in a safe zone if a current limitation of 50 % is assumed and this reduced current is used to establish the trip time, as determined from the current-time curve. Thus, the current limiting factor equates to  $k_B = 0.5$ ; it follows that:

$$I_{k, arc} = 0.5 \cdot I''_{k3, min}$$

When using scatter range information for the current-time characteristic curve for an overcurrent protection device (e.g. fuse), the value from the upper range limit should be used for the short-circuit duration.

*Remark 1:*

*When determining the trip time, the relevant overcurrent protection device from the respective work area should be preferentially used. This can also include overcurrent protection devices that are used or activated on location only during the work time, such as so-called “Safe work fuses”. With a multi-source feed to the work area, the overcurrent protection device with the longest trip time should be used to determine short-circuit duration.*

*Remark 2:*

*When using software tools (selectivity calculations), it must be ensured that the calculation is made on the basis of the limited electric arc short-circuit current  $I_{k, arc}$ .*

Regarding the overcurrent protection devices, their range of protection and selectivity levels must be considered. With non-current-limiting fuses and circuit breakers with

direct actuation, the short-circuit duration can be taken directly from the current-time curve or from the temporal selectivity increments (selective tripping schedule). The circuit breaker time delay level or selective trip time settings must also be considered, if applicable. The following reference values are considered to be typical for circuit breaker trip times without a time delay:

**Table A 3-1** Typical circuit breaker trip times

Circuit breaker	Instantaneous trip time
Low voltage (< 1000V)	60 ms
Medium voltage (1 to 35 kV)	100 ms
High voltage (> 35 kV)	150 ms

Related information provided by the manufacturer will provide more precise specifications.

Current limiting fuses feature a short-circuit duration of less than 10 ms. The current-time curves for the fuses exhibit the virtual melting times, meaning the actual trip times will not necessarily coincide. For safety reasons, fuses used in current limiting situations should feature a short-circuit duration  $t_k = 10$  ms. This value is considered to be on the safe side.

*Note:*

*At short-circuit durations longer than 1 s, it can be assumed that the person will be able to withdraw from the immediate danger area, if necessary. For this reason, longer periods will not need to be considered. This does not apply, however, if the person’s departure from the work environment is precluded or restricted, such as when working in tight cable trenches or canals, narrow work corridors, or working from ladders or lifting mechanisms.*

**A 3.4.3.1 Particular aspects of short-circuit duration determinations for DC systems**

As a rule, the trip time characteristic curves provided by the fuse manufacturer specify virtual melting times for an electric circuit with a time constant of  $\tau = 0$ . In practice, for the most part, the extension of the melting time or trip



time for  $\tau \neq 0$  can be disregarded because the short-circuit duration is large in comparison to the time constant. Generally, the conversion instructions provided by the fuse manufacturer should be followed. This applies analogous for circuit breakers, as well.

#### A 3.4.4 Determine the expected value of electric arc energy

The maximum expected value of electric arc energy at the respective fault location or within the work situation being considered is to be determined.

Electric arc energy is dependent on network conditions, meaning from the network short-circuit power  $S_k''$  at the potential fault location and the short-circuit duration  $t_k$ , as determined by the electric overcurrent protection devices (trip times for circuit breakers and fuses, as well as separate protection devices if applicable) from the protection characteristic curves:

$$\begin{aligned} W_{\text{arc}} &= P_{\text{arc}} \cdot t_{\text{arc}} \\ &= k_p \cdot S_k'' \cdot t_k \\ &= k_p \cdot \sqrt{3} \cdot U_{\text{Nn}} \cdot I_{k3,\text{max}}'' \cdot t_k \end{aligned}$$

The network short-circuit power at the fault location results from the nominal voltage or the contracted network supply voltage  $U_{\text{Nn}}$  and the maximum prospective 3-pole short-circuit current  $I_{k3,\text{max}}''$  for the relevant network switching states.

With a multi-source feed to the fault location, the short-circuit current  $I_{k3,\text{max}}''$  is comprised of the respective partial currents. That portion of short-circuit current from motors that could be fed back to the fault location must be accounted for, if applicable.

In general, if a fault occurs within the switchgear or distribution systems, the line impedance between the supply source (usually a transformer) and the system must be accounted for.

Furthermore, electric arc energy is dependent on system conditions characterized by factor  $k_p$ , which accounts for the type of arc formation and the electrode geometry at the fault location. This factor can be determined by approximation using the electric arc voltage. Empirical con-

ditional equations apply to the electric arc voltage, which – aside from electrical circuit parameters – require knowledge of system conductor wire spacing. The 50 % arc voltage value determination can be assumed [21].

For a very rough estimation without considering the system geometry, the theoretical maxima of the parameter  $k_p$  can be used, which can be determined using the following equation:

$$k_{p\text{max}} = \frac{0.29}{(R/X)^{0.17}}$$

$R$  is the active component thereby, while  $X$  is the reactive component of impedance in the short-circuit electrical circuit.

This worst-case calculation should always be used when electrode arrays are aligned directly towards working personnel (see Fig. A 3-1).

Furthermore, it was determined that the following specified range of values  $k_p$  is typical for conventional system configurations in practice, so that these can be used as reference values (Table A 3-2).



Abb. A 3-1 Electrode array aligned directly towards working personnel

**Table A 3-2** Reference values for Normalized arc power

Nominal network voltage $U_{Nn}$	Distance $d$	Resistance/Reactance ratio $R/X$	Normalized arc power $k_p$
400 V	30 mm	0.2	0.229
		0.5	0.215
		1.0	0.199
		$\geq 2.0$	0.181
	45 mm	0.2	0.289
		0.5	0.263
		1.0	0.240
		$\geq 2.0$	0.222
	60 mm	0.2	0.338
		0.5	0.299
		1.0	0.270
		$\geq 2.0$	0.253
10 to 20 kV	120 to 240	0.1	0.04 to 0,08

Note:

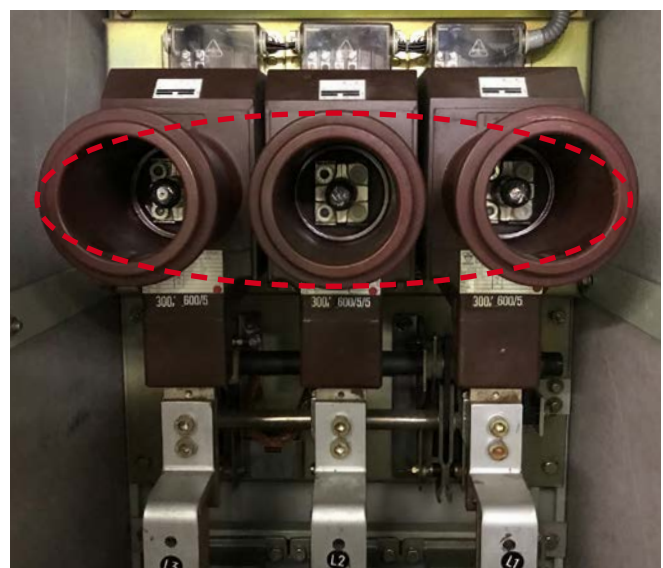
When using the maximum value or the reference value, the determination of geometric parameters is circumvented at the cost of precision. A significantly safe distance can emerge under certain circumstances, particularly by applying the maximum value.

#### A 3.4.4.1 Particular aspects of expected electric arc energy value determinations for DC systems

In contrast to the determination of electric arc energy in AC and three-phase AC systems, an iterative approach is used for determining the electric arc short-circuit current and the electric arc power in DC systems, which then is used to determine the arc energy. The starting point is to identify the current-voltage characteristic of the DC electric arc using the equation to arrive at an approximation:  

$$U_{\text{arc}} = (34 + 0.532 \cdot d) \cdot I_{k, \text{arc}}^{0.12}$$

Note:

In the equation provided, the electric arc short-circuit current is used for A. Using the electrode gap in mm results in the electric arc voltage in V.

This approximation equation is derived from technical measurement analyses and describes the reciprocal cur-

rent-voltage-correlation associated with the arc flash, for which working points are set for electric arc short-circuiting in the equivalent DC circuit. For simplification, the equivalent circuit is linearized, which considers the arc flash as a linear ohmic resistance  $R_{\text{arc}}$ . The following applies for the linearized electric circuit

$$U_{Nn} = I_{k, \text{arc}} \cdot (R_{\text{arc}} + R_N).$$

Resistance  $R_N$  is the ohmic resistance of the DC system with short-circuited electric arcing and, consequently, is the result of the nominal network voltage  $U_{Nn}$  and the prospective (bolted) short-circuit current  $I_{kDC}$  according to  $R_N = U_{Nn} / I_{kDC}$ .

Using the approach for the electric arc voltage  $U_{\text{arc}}$ , the linear arc resistance  $R_{\text{arc}} = U_{\text{arc}} / I_{k, \text{arc}}$  is determined, which is subsequently used to determine the electric arc short-circuit current  $I_{k, \text{arc}}$  on the basis of the electric circuit equation:  

$$I_{k, \text{arc}} = U_{Nn} / (R_{\text{arc}} + R_N).$$

For this, it follows that an iteration process will be necessary.

The value for electric arc short-circuit current is prescribed in the first step in the iteration process. As a matter of convenience, a value of 50 % of the bolted short-circuit current in the electric circuit is used:  $I_{k, \text{arc}} = 0.5 \cdot I_{k\text{DC}}$ . This allows for the electric arc voltage and, subsequently, the associated electric arc resistance to be calculated. With the electric arc resistance, the corrected electric arc short-circuit current can be determined, which then facilitates determination of the electric arc voltage in the next iteration step. The correlated values of electric arc voltage and electric arc short-circuit current in the relevant iteration step  $i$  results in the electric arc power for  $P_{\text{arc}(i)} = U_{\text{arc}(i)} \cdot I_{k, \text{arc}(i)}$ . The iteration is complete when a suitable abort criterion has been attained. A deviation of less than 0.5 % can be viewed as being suitable.

For a rough estimation, the electric arc power can also approximate the maximum power to be determined in a viable linear resistance power. For linear DC circuits, this equates to a maximum power at 25 % of the short-circuit power  $P_k = U_{Nn} \cdot I_{k\text{DC}} = U_{Nn}^2 / R_N$ .

The normalized arc power then equals  $k_{p, \text{max}} = 0.25$ . Electric arc power is determined according to  $P_{\text{arc}, \text{max}} = 0.25 \cdot P_k$ .

Analogous to the AC system, the arc energy is calculated from the resulting electric arc power and the short-circuit duration. Short-circuit duration is determined from the trip time characteristic curves for the overcurrent protection devices using the electric arc short-circuit current.

#### A 3.4.5 Determine the working distance

Working distance  $a$  is the distance between the electric fault arc and the operative part of a person's body (torso) while performing work or while present in the working environment under consideration. Where different tasks are being carried out in the working environment, the shortest distance emerging should be applied. The configuration of the potential electric arc-related electrodes in the system (conductor arrangement) is decisive for determining the fault location (location of the electric arc flash).

Those electrical installations, on which persons perform electrotechnical work on open equipment (repairs, service and maintenance, assembly, inspection, measurement, etc.) are designated as the working environment and workstations. A work task is considered to be any activity performed in the vicinity of live components or live working.

Typical working distances resulting from the person's working posture and the characteristic design or geometry and dimensions of the electrical installation are:

**Table A 3-3** Typical working distances

Equipment type	Typical working distances
Low voltage distribution/ house junction box, main control cabinet	300 to 450 mm
Low voltage switchgear	300 to 600 mm
Medium voltage switchgear	$\geq 825$ mm

Distance relationships should be determined as accurately as possible in order to establish the working distance. Yet, it can generally be assumed that the distance to the person's torso while working will not fall below  $a = 300$  mm and that this can be applied as a reference value, particularly in the low voltage range.

*Note:*

*Personal protection can always be assumed when working on closed systems that have passed design testing for arc resistance; consequently, a working distance does not need to be determined (refer to Section 3.4.1). In the case of non-tested systems, however, the potential for electric arcing and related effects outside the installation should be anticipated (e.g. when opening doors). The working distance that must then be considered is comprised of the distance to the installation enclosure and the typical working distances referenced above (values taken from the lower limits).*

Establishing a safe, minimum working distance to be maintained by a worker represents one potential measure aimed at facilitating work activities using PPEaA at a specific level of protection (test category or Arc protection class).

### A 3.4.6 Determine the Arc protection level of the PPEaA

Using a Box test setup according to DIN EN 61482-1-2 (VDE 0682-306-1-2) [11] ensures that the thermal transfer relationships (including output electrode material) will conform to worst-case conditions. Application limits for PPEaA can be taken from the electric arc energies  $W_{\text{arc, test}}$  in the test settings, which correspond to the respective incident energies  $E_{\text{iOP}}$  in the test:

**Table A 3-4** Box test parameters

Box test DIN EN 61482-1-2 (VDE 0682-306-1-2)	Statistical mean value	
	Arc protection class	Statistical mean value
	Electric arc energy $W_{\text{arc, test}}$	Direct incident energy $E_{\text{iOP}}$
APC 1	168 kJ	146 kJ/m <sup>2</sup>
APC 2	320 kJ	427 kJ/ m <sup>2</sup>

*Note:*

The specified direct incident energy values  $E_{\text{iOP}}$  that distinguish the Arc protection classes in the Box test method do not correspond with the ATPV values determined in the tests according to DIN EN 61482-1-1 (VDE 0682-306-1-1) [10] or in the subsequent methods according to NFPA 70E [14] and IEEE 1584 [15]; neither are the underlying transmission or exposure requirements comparable, nor are the analytical conversions or mathematical conveyances possible using these values.

At an operative distance of  $a = 300$  mm (corresponding to the test setup), the electric arc energy values  $W_{\text{arc, test}}$  lead to the incident energies under consideration. Electric arc energy  $W_{\text{arc, test}}$ , which identifies the Arc protection class in the Box test, is used as a comparative parameter  $W_{\text{arc, prot}}$  for the ascertained electric arc energy  $W_{\text{arc}}$  within the scope of application.

At the same time, it is presupposed that the use of PPEaA is foreseen for working distances of  $a = 300$  mm and for small-scale installations limited by side, rear and partition walls analogous to the Box test setup (with a volume of around  $V = 1.6 \cdot 10^{-3}$  m<sup>3</sup>) (refer to Fig. 4-5). Corrections are possible for divergent conditions.

#### A 3.4.6.1 Arc protection level of the PPEaA for DC systems

For DC applications, as well, the protection level of the PPEaA is determined using the AC test levels from the Box test  $W_{\text{arc, test}}$ .

*Note:*

Examinations verified that the energy relationships in DC systems are covered by the applicable requirements for AC systems [28].

#### A 3.4.7 Consider the divergent exposure relationships

A protection level (equivalent arc energy)  $W_{\text{arc, prot}}$ , at which protection is still afforded by the PPEaA for the distance  $a$  in question, can be determined for any working distance  $a$  from the electric arc energy for the test category  $W_{\text{arc, test}}$  using the experimentally verified reverse squared distance proportionality. Furthermore, the system configuration can also be accounted for. The applicable basic formula for the Box test is

$$W_{\text{arc, prot}} = k_T \cdot \left( \frac{a}{300 \text{ mm}} \right)^2 \cdot W_{\text{arc, test}}$$

The transmission factor  $k_T$  for the arc energy for the Box test conditions equates to  $k_T = 1$ . For divergent firing and transmission conditions, the transmission factor  $k_T$  can also be set with the following values:

**Table A 3-5** Transmission factor  $k_T$

Type of system	Transmission factor $k_T$
(Very) small-scale systems with side, rear and partition walls	1
Large-scale systems, spatial limitations primarily due to rear wall structure	1.5 to 1.9
Open systems without significant limitations in the electrode chamber	2.4

#### A 3.4.7.1 Consider the divergent exposure relationships for DC systems

The transmission factor  $k_T$  from Table A 3-5 can also be used for DC systems. Determination of the protection level of PPEaA also takes place in the same manner as for AC systems using the AC test levels from the Box test  $W_{\text{arc, test}}$ .

These examinations verified that the thermal transfer relationships in DC systems are covered by the applicable requirements for AC systems [28].

#### A 3.4.8 Using the analysis results for the Risk assessment

In the Risk assessment or when selecting the PPEaA test category or Arc protection class (Box test), the relation to the expected value for electric arc energy is to be considered on the basis of the equivalent arc energy. Protection against the Thermal hazards due to electric fault arcing is realized when the electric arc energy  $W_{\text{arc}}$  is less than or equal to the protection level (equivalent arc energy)  $W_{\text{arc, prot}}$ .

$$W_{\text{arc}} \leq W_{\text{arc, prot}}$$

Starting with this relation together with the above mentioned determinant parameters and equations, the limits for PPEaA applicability in a chosen test category or Arc protection class can be determined with respect to the short-circuit current range, permissible short-circuit duration or protection fuse trip time (and therewith the over-current protection fuse itself) and permissible working distance.

### A 3.5 Alternative test methods

The procedures described herein are not applicable for alternative test methods to the Box test method. It is then necessary to determine the correlation between electrical energy and direct incident energy (transmission function) generally valid for the test setup in question or to ascertain the direct incident energy that can be expected during individual applications in the event of an accident, and then to compare these with the incident energy level from the PPEaA test.

In addition to the Box test, a test method will be applied in accordance with DIN EN 61482-1-1 (VDE 0682-306-1-1) [10] (Open-Arc test). As opposed to the Box test method, in which a directed test arc is generated similar to an arc flash that might be expected in an accident when working on a control cabinet or distribution system, the electric fault arc generated in the Open-Arc method is open and non-directional, meaning it is generated in a quasi-open area. The two methods cannot be directly compared and are not transferable or convertible among themselves. On the one hand, this is due to the type of electric fault arc, whose length and propagation are predetermined by the test setup, the electrode materials used and many other physical-technical differences. With the Open-Arc test, the heat transfer that takes place is primarily due to radiation.

On the other hand, the Open-Arc test results lead to the so-called "Arc Thermal Performance Value", or ATPV. Using a statistical methodology in this context, the incident energy is determined, at which level a 50 % probability exists that 2nd degree skin burns will be suffered behind the PPE. Even if an electric arc accident is relatively improbable, the EU regulation related to PPE allows no interpretation of PPE that would tolerate such injury. For this reason, this test method could generally not be used within the EU until July 2019. Only with the 2nd Edition of IEC 61482-1-1: 07-2019 will the prerequisite be established through determination of an additional result parameter ELIM, that the presumption of conformity to the EU regulation can be fulfilled using Open-Arc testing (refer also to A 2.3).

ATPV is the direct incident energy that is generated with the special transfer relations existing in the test. It should be noted that neither the ATPV nor the ELIM are in accord with the direct incident energy levels associated with the

test categories from the Box test. The incident energy levels from the Box test method are neither ATPV or ELIM values nor limits to the range of ATPV or ELIM.

Products available on the international market have been tested under certain circumstances according to both methods, meaning the Box test and the Open-Arc test. Even if the test results are not directly comparable, they can nevertheless help in the selection of suitable PPEaA, particularly when the maximum expected electric arc energy lies above the electric arc energy described in A 3.4.4. for the Arc protection class  $W_{\text{arc, test}}$  (test level) or the equivalent arc energy  $W_{\text{arc, prot}}$  (protection level).

For this reason, a manufacturer who tests its products according to both methods can also specify the resulting ELIM for the EU market in order to provide the user with further criterion to facilitate the selection of suitable PPEaA.

When using ATPV and ELIM for selecting PPEaA, however, a risk analysis must be undertaken, in which the expected incident energy is ascertained. Corresponding algorithms are provided for this in NFPA 70E [14] and in IEEE 1584 [15].

Nevertheless, it must be noted that ATPV-based testing and PPEaA selection are bound by the limitations of this methodology.

# Annex 4

## Application of the Risk matrix

### A 4.1 General

Many years of practical operational experience with PPEaA generally reveal that, when PPEaA was properly worn, injuries have not resulted from electric arc incidents – even at times when the calculated PPEaA protection level had been exceeded. This shows that the calculation methodology (Section 3 Phase 3) usually incorporates sufficient safety reserves, especially because, in many cases, the partially assumed worst-case conditions are not all present at the same time.

Moreover, those not directly quantifiable influencing factors, such as personnel qualifications, the use of bypass-resistant equipment or the absence of arc flash propagation options, could have significantly reduced the risk of injury due to electric arcing without the factors having been depicted in a calculation methodology to date.

With the expanded approach to the Risk assessment described in the following text, further measures (technical, organizational, personal) and influencing factors (statistical, ergonomic) that go beyond the numerical arithmetic parameters previously evaluated are now considered (Fig. A 4-1).

The Risk assessment opens the possibility of allowing for the calculated PPEaA protection levels to be exceeded under certain conditions within specified limits if the resulting risk of injury is sufficiently low. This is achieved through the use of a Risk matrix (Section 3, Fig. 3-2) and the application methods described below. The residual risk of an injury due to electric fault arcing is the link between the anticipated severity of injury and the anticipated probability of injury – while accounting for the respective measures adopted.

The Risk matrix can be applied only when the results of the calculation process (Section 3, Phase 3) exceed the calculated PPEaA protection level. An estimation is then made of the probability of electric arcing and the severity of related injury after the adopted measures have been implemented.

The resulting residual risk is then evaluated (Risk matrix):

“green”: Work activities may be carried out

“yellow”: Work activities may be carried out, but active risk management is required:

- The risk is to be maintained as low as reasonably practicable (ALARP) according to DIN EN 31010 (VDE 0050-1),
- Case-by-case evaluation,

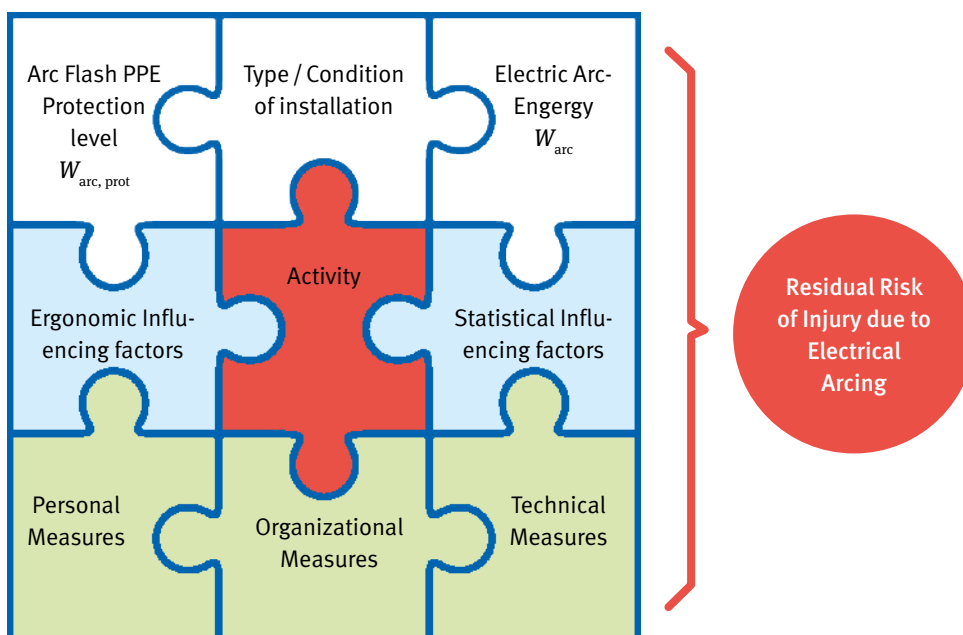

Fig. A 4-1

Overall evaluation of the influencing factors results in the electric arc hazard

- Regular inspections to determine whether further technical, organizational or personal measures are possible,
- Specify a cycle, if applicable

“red”: Work activities must not be carried out under these circumstances:

- Implement further measures according to Phase 5, if applicable,
- The installation may need to be isolated, if applicable.

#### A 4.2 Evaluation of the anticipated severity of injury

The anticipated severity of injury due to an electric arc occurrence must be evaluated with consideration given to all adopted safety measures. The most serious personal risks are associated with the thermal effects of electric fault arcing.

The degree of severity of a burn is generally dependent on a multitude of complex factors, such as the intensity and the duration of the heat flow acting upon the surface of the skin and the resulting rise in temperature at the different layers of the skin. In this methodology, a simplified estimation is made of the anticipated severity of injury using the relationship of the expected arc energy ( $W_{arc}$ ) from the arc flash to the calculated PPEaA protection level ( $W_{arc, prot}$ ) corresponding to the following Table A 4-1.

*Remark 1:*

*The values specified in Table A 4-1 are based on a review of literature and determinations made by the Electric fault arc working group, and maintain a safety distance that is deemed sufficient by experts.*

*Remark 2:*

*This DGUV Information does not address potential hazards associated with the collateral effects of an arc flash, such as those due to pressure, acoustic shock, particles flying off, radiation, molten particles or gases. These hazards must be considered separately, if applicable.*

#### A 4.3 Evaluation of the probability of occurrence

When using the Risk matrix, the anticipated probability of an injurious occurrence (PO) due to electric fault arcing (EFA) must be estimated with consideration given to all adopted measures. The anticipated probability of injury thereby will be influenced by both those measures adopted to prevent the occurrence of electric arcing, as well as those measures adopted to prevent the effects of a potential arc flash (Fig. A 4-2).

The possible categories for the probability of injury due to electric arcing are listed in Table A 4-2.

**Table A 4-1** Evaluation criteria for determining the potential severity of injury

	Designation	Description	Electric arc energy / Protection level
1	Slight injury	Skin burn < 2nd degree	$W_{arc} / W_{arc, prot} \leq 1$
2	Reversible injury	2nd degree skin burns Blistering, severe pain, complete healing or with scarring	$1 < W_{arc} / W_{arc, prot} \leq 3$
3	Irreversible injury	3rd degree skin burns; deeper layer skin burns	$3 < W_{arc} / W_{arc, prot} \leq 10$
4	Fatal injury	3rd degree skin burns or more severe, extensive, irreversible, with fatal consequences	$W_{arc} / W_{arc, prot} > 10$



**Fig. A 4-2**  
Influence of the measures adopted to prevent the effects of potential electric fault arcing

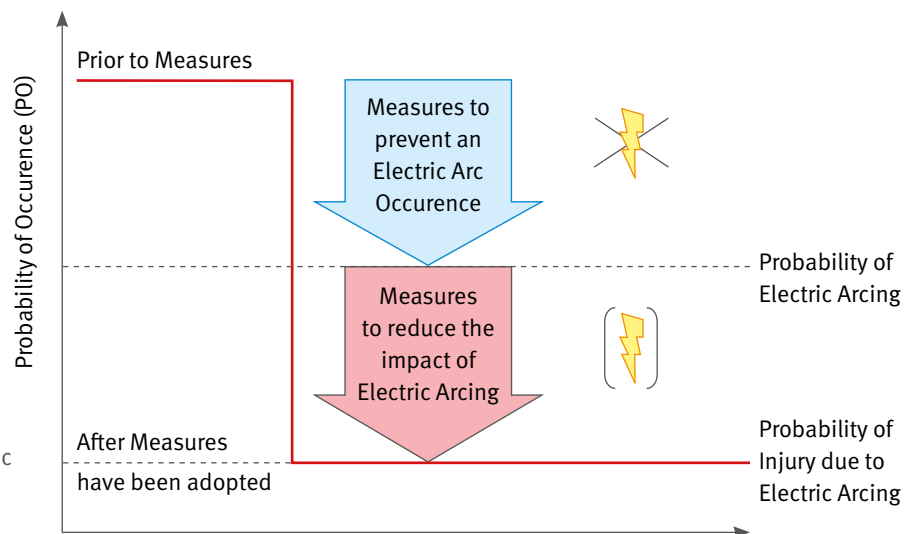

The probability of injury due to electric arcing can also be differentially estimated on the basis of detailed evaluation criteria (Table A 4-3). For this, evaluation points are used that are assigned to the evaluation criteria below:

- a) Type/condition of equipment
- b) Technical measures
- c) Organizational measures
- d) Personal measures
- e) Statistical influencing factors
- f) Ergonomic influencing factors

The sum of the evaluation points results in a value that can be used to help determine the probability of occurrence (refer to Fig. A 4-3).

Each criterion considered should be evaluated with respect to the activity/activity group performed and to the existing installation/type of equipment, as well as to its interaction with other criteria according to Table A 4-3.

Evaluation points 0 to 10 should be assigned based on how much influence the respective criterion has on the probability of injury.

Influence leads to the probability of injury:

- |    |                                |
|----|--------------------------------|
| 0  | Practically impossible         |
| 2  | Conceivable, but very unlikely |
| 4  | Unlikely                       |
| 7  | Seldom                         |
| 10 | Occasional to frequent         |

If a criterion does not apply (e.g. an appropriate measure is not possible, statistical data is not available, etc.), the value of the evaluation points for this criterion should be set into the average value of the other criteria evaluated so that the results will not be distorted.

Example:

- |              |                                   |
|--------------|-----------------------------------|
| Criterion a) | ... 4 points                      |
| Criterion b) | ... not applicable                |
|              | → Value will be set to 3.5 points |
| Criterion c) | ... 2 points                      |
| Criterion d) | ... 4 points                      |
| Criterion e) | ... not applicable                |
|              | → Value will be set to 3.5 points |
| Criterion f) | ... 4 points                      |

The evaluation of criteria a, c, d and f together results in 14 points. The value of the not applicable criteria b and e is set to a value of 3.5 (= 14/4: the average value of the 4 other criteria).

**Table A 4-2** Anticipated average frequency of injury of an employee after implementing the adopted measures

	Designation	Description	Frequency
1	Practically impossible	Injury is not anticipated.	< 1x in 100 years
2	Conceivable, but very unlikely	Theoretical considerations indicate that an injury is possible, but would not be anticipated in practice, under reasonably foreseeable conditions.	1x in 100 years
3	Unlikely	There is an awareness of accidents throughout industry is aware of accidents that cannot be excluded, but are very rare.	1x in 50 years
4	Seldom	Injury due to electric fault arcing is quite possible.	1x in 10 years
5	Occasional to frequent	Injury due to electric fault arcing should be anticipated.	monthly ... yearly

**Table A 4-3** Criteria for estimating the probability of injury

	Designation	Description	Possible evaluation points (influence on PO)
a)	Type/condition of equipment	Type/condition of equipment with respect to the potential bridging capacity (electric arc formation) or the limitation of electric arc impact, e.g. <ul style="list-style-type: none"> <li>• Open, bridging potential (potential distances, bridging capacity, e.g. through tooling/accessories or falling conductive parts, if applicable)</li> <li>• Separation from adjoining panels/separation of potentials (e.g. division bars)</li> <li>• Contamination, moisture, growth</li> <li>• Maintenance and testing</li> <li>• Age of the installation</li> <li>• Particular environmental concerns (e.g. climatic conditions)</li> <li>• Installation with closed doors</li> <li>• Protection against physical contact (e.g. VDE 0660-514)</li> <li>• Low voltage equipment according to VDE 0660-600-2, Supplemental sheet 1 (Electric arc tested equipment)</li> <li>• Base point-free low voltage equipment</li> <li>• Medium voltage equipment according to VDE 0671-200 (Electric arc tested equipment)</li> <li>• Switching fault protection</li> </ul>	0 ... Practically impossible 2 ... Conceivable, but very unlikely 4 ... Unlikely 7 ... Seldom 10 ... Occasional to frequent
b)	Technical measures	Technical measures to prevent potential bridging (arc flash formation) or to limit electric arc impact, e.g. <ul style="list-style-type: none"> <li>• The use of tools or equipment (with regard to protection against bridging, distance)</li> <li>• The use of protective and auxiliary resources</li> <li>• The condition of work resources</li> <li>• The use of measuring devices (e.g. suitable measurement category)</li> <li>• Active electric arc protection system</li> <li>• Safe work fuses</li> <li>• Monitoring of the effectiveness of the technical measures</li> </ul>	0 ... Practically impossible 2 ... Conceivable, but very unlikely 4 ... Unlikely 7 ... Seldom 10 ... Occasional to frequent Not applicable

	Designation	Description	Possible evaluation points (influence on PO)
c)	Organizational measures	<p>Organizational measures to prevent potential bridging (arc flash formation) or to limit electric arc impact, e.g.</p> <ul style="list-style-type: none"> <li>Organizational rules (e.g. operating/work instructions): <ul style="list-style-type: none"> <li>Responsibilities</li> <li>Protective measures against electric fault arc (e.g. testing for fault-free status)</li> <li>Teaching/training</li> <li>Verification of effectiveness</li> <li>Equipment documentation</li> <li>Rules of entry for electrical installations</li> <li>Instruction related to electrical equipment</li> </ul> </li> <li>Dealing with electrical accidents/incidents: <ul style="list-style-type: none"> <li>Analysis/Communication</li> <li>Measures/Monitor the effectiveness of measures</li> </ul> </li> <li>When performing switching operations: <ul style="list-style-type: none"> <li>Operational rules/Organization of switching operations</li> <li>Documentation of switching operations</li> <li>Switching qualification/Switching authority</li> <li>Retention of qualifications</li> </ul> </li> <li>When performing live work: <ul style="list-style-type: none"> <li>Instructions for live working (protection measures against electric arcing)</li> <li>Qualified electricians as instructors</li> <li>Special training</li> <li>Retaining qualifications</li> <li>Control (quality assurance)</li> </ul> </li> <li>Dealing with outside personnel: <ul style="list-style-type: none"> <li>Requirements/Prequalification</li> <li>Instruction/training</li> <li>Retaining qualifications</li> <li>Control (quality assurance)</li> </ul> </li> </ul>	<p>0 ... Practically impossible</p> <p>2 ... Conceivable, but very unlikely</p> <p>4 ... Unlikely</p> <p>7 ... Seldom</p> <p>10 ... Occasional to frequent</p> <p>Not applicable</p>
d)	Personal measures	<p>Personal measures to prevent potential bridging (arc flash formation) or to limit electric arc impact, e.g.</p> <ul style="list-style-type: none"> <li>The use of PPEaA <ul style="list-style-type: none"> <li>The selection of PPEaA (Arc protection class)</li> <li>Application/Testing (e.g. visual inspection)</li> <li>Routine care, maintenance and repair</li> <li>Verification of usage/Quality assurance</li> </ul> </li> <li>Qualification of operative personnel: <ul style="list-style-type: none"> <li>Activity-specific/equipment-specific knowledge</li> <li>Work methods and experience</li> <li>Instruction</li> <li>Special qualifications (e.g. switching qualification, live working)</li> <li>Retention of qualifications</li> <li>Monitoring of qualifications</li> </ul> </li> </ul>	<p>0 ... Practically impossible</p> <p>2 ... Conceivable, but very unlikely</p> <p>4 ... Unlikely</p> <p>7 ... Seldom</p> <p>10 ... Occasional to frequent</p> <p>Not applicable</p>

	Designation	Description	Possible evaluation points (influence on PO)
e)	Statistical influencing factors	Statistical influencing factors that play a role when evaluating the probability of electric arc occurrence or injury due to electric arcing, such as <ul style="list-style-type: none"> <li>• Accident statistics (e.g. the frequency of accidents on the basis of in-house operational experience or known accidents and statistical data)</li> <li>• Further stochastic factors (e.g. the frequency/duration of activities with exposure to electric arcing, task-related: e.g. voltage testing of equipment that has already been isolated)</li> </ul>	
f)	Ergonomic influencing factors	Ergonomic influencing factors that play a role when evaluating the probability of electric arc occurrence or injury due to electric arcing, such as <ul style="list-style-type: none"> <li>• PPEaA Wearing comfort (e.g. Fit, hygiene, tactility) Wearing acceptance</li> <li>• Work environment (e.g. freedom of movement, forced posture, lighting, climatic conditions) Psychological stress (e.g. Time pressure, diversions)</li> </ul>	0 ... Practically impossible 2 ... Conceivable, but very unlikely 4 ... Unlikely 7 ... Seldom 10 ... Occasional to frequent Not applicable

The sum of the evaluation points for the criteria a) to f) results in the classification of the anticipated probability of injury in the Risk matrix (Fig. A 4-3):



	Probability of injury (evaluation points)	1 (0 to 9)	2 (10 to 19)	3 (20 to 30)	4 (31 to 45)	5 (46 to 60)
Severity of damage (Severity of injury)		Practically impossible	Conceivable, but very unlikely	Unlikely	Seldom	Occasional to frequent
1	Slight injury					
2	Reversible injury					
3	Irreversible injury					
4	Fatal injury					

Fig. A 4-3 Risk matrix with a summation of evaluation points

# Annex 5

## Examples

The following examples depict work being carried out at different work locations in a typical municipal low voltage supply system.

Note:

The following examples were compiled from the viewpoint of the experts who have collaborated on this DGUV Information. The examples are provided in support of those who apply this selection guide. Individual evaluations undertaken in operational practice may account for local conditions or specific work processes that bring about different results.

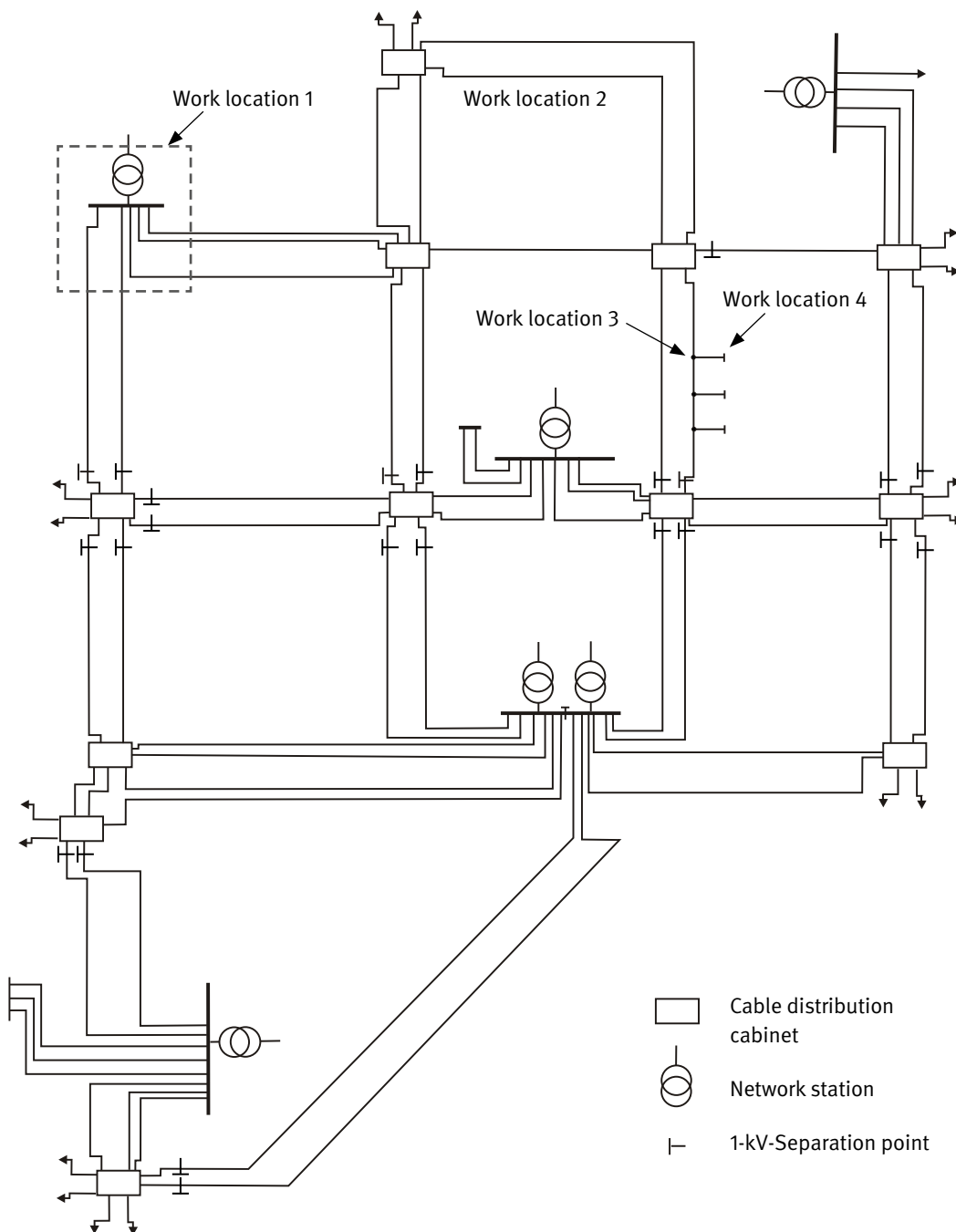

Fig. A 5-1  
Municipal low voltage supply system being considered

### A 5.1 Example 5.1: Low voltage distribution in a transformer station (Work location 1)

Work tasks are frequently carried out on low voltage distribution systems at transformer stations. Examples might be the removal or replacement of NH fuse-links, connection and disconnection of output circuitry, measurement and testing of active components or cleaning tasks.



Fig. A 5-2  
Working on a low voltage  
distribution system

#### Risk assessment of the planned activities

*Phase 1: Is there a principle danger of exposure to persons due to electric arcing?*

- Yes
- Work tasks are performed that require physical contact with open live installation, on which electric arcing can occur.

*Phase 2: Initial evaluation of electric arc energy associated with the scope of activity or workplace. Is a calculation required?*

- Yes
- When working on low voltage installations, PPEaA can be dispensed with in the following situations:
  - When working on measuring, control and regulation equipment with upstream electric circuit protection up to 25 A.
  - not applicable

- When working on electrical circuitry with rated voltages up to 400 V with upstream protection up to and including 63 A, insofar as an outfit of customary work clothing comprised of long-sleeved outer clothing and long pants is worn.  
 .....→ not applicable
- When working on electrical circuitry with rated voltages up to 400 V AC and a short-circuit current < 1 kA. (such an electric arc will burn unstably and extinguish immediately.)  
 .....→ not applicable

An increased degree of risk exists when performing the work in question because, in the event of a fault at the workplace, significant short-circuit power is generated directly behind the transformer. The transformer output, as well as the transformer fuses or power supply branch circuit breaker trip times are decisive for the energy released into an arc flash. One important factor is influenced by the structure or the switching status of the low voltage network with relationship to the type of energy supply to the low voltage stations (station meshing or per station low voltage network supply). The short-circuit power and the prospective short-circuit current at the workplace depend on whether a unilateral or a multilateral supply exists.

### Phase 3: Apply the calculation methodology: Determine $W_{\text{arc}}$ , $W_{\text{arc, prot}}$ !

#### Step 1: Data for the workplace being considered

This example deals with a municipal supply system (Fig. A 5-3), in which Work location 1 will be considered. There are 20/0.4 kV transformers present at the network stations with rated capacities  $S_{\text{rT}}$  of 630 kVA or 400 kVA and short-circuit voltages  $u_k$  of 4 %. The standard 1-kV aluminium cable cross-sections are 150 mm<sup>2</sup> for the network cables and 35 mm<sup>2</sup> for the house installation cables.

The drawing in Fig. 5-1 depicts the network separation points, which can be opened during work on live components in order to establish a unilateral energy supply to the respective network areas in question. Work location 1 is supplied by a 630 kVA transformer over a 630 kVA NH transformer fuse with operating class gTr AC 400 V. The fuse current-time curve is depicted in Fig. 5-4.

#### Step 2: Determination of $I''_{k3}$ , $R/X$

The results from the short-circuit current calculation according to VDE 0102 [7] for the unilateral energy supply switching status at the work location yield a prospective short-circuit current (initial short-circuit alternating current)  $I''_{k3}$  of

$$\begin{aligned} I''_{k3, \text{max}} &= 24.5 \text{ kA} & (c = 1.05) \\ I''_{k3, \text{min}} &= 21.6 \text{ kA} & (c = 0.95) \end{aligned}$$

The  $R/X$  ratio for network impedance in the fault circuit equates to approximately 0.27.

#### Step 3: Determination of Electric arc current

The minimum fault current relevant for the NH fuse trip time with an electric arc short-circuit current results from the minimum prospective short-circuit current  $I''_{k3, \text{min}}$  using the limiting factor  $k_B$ , which characterizes the current-limiting effects of the electric arc in the fault circuit. Because a low voltage system and a worst-case examination are being dealt with in the initial approach, a current limiting factor of  $k_B = 0.5$  will be assumed according to Section 4.2.2. For minimum fault current, it follows that

$$I_{k, \text{arc}} = k_B \cdot I''_{k3, \text{min}} = 0.5 \cdot 21.6 \text{ kA} = 10.8 \text{ kA}$$

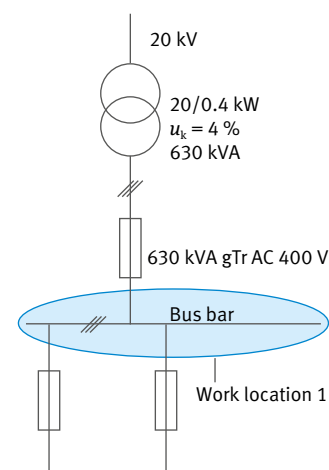

Fig. A 5-3  
Equivalent circuit  
at Work location 1

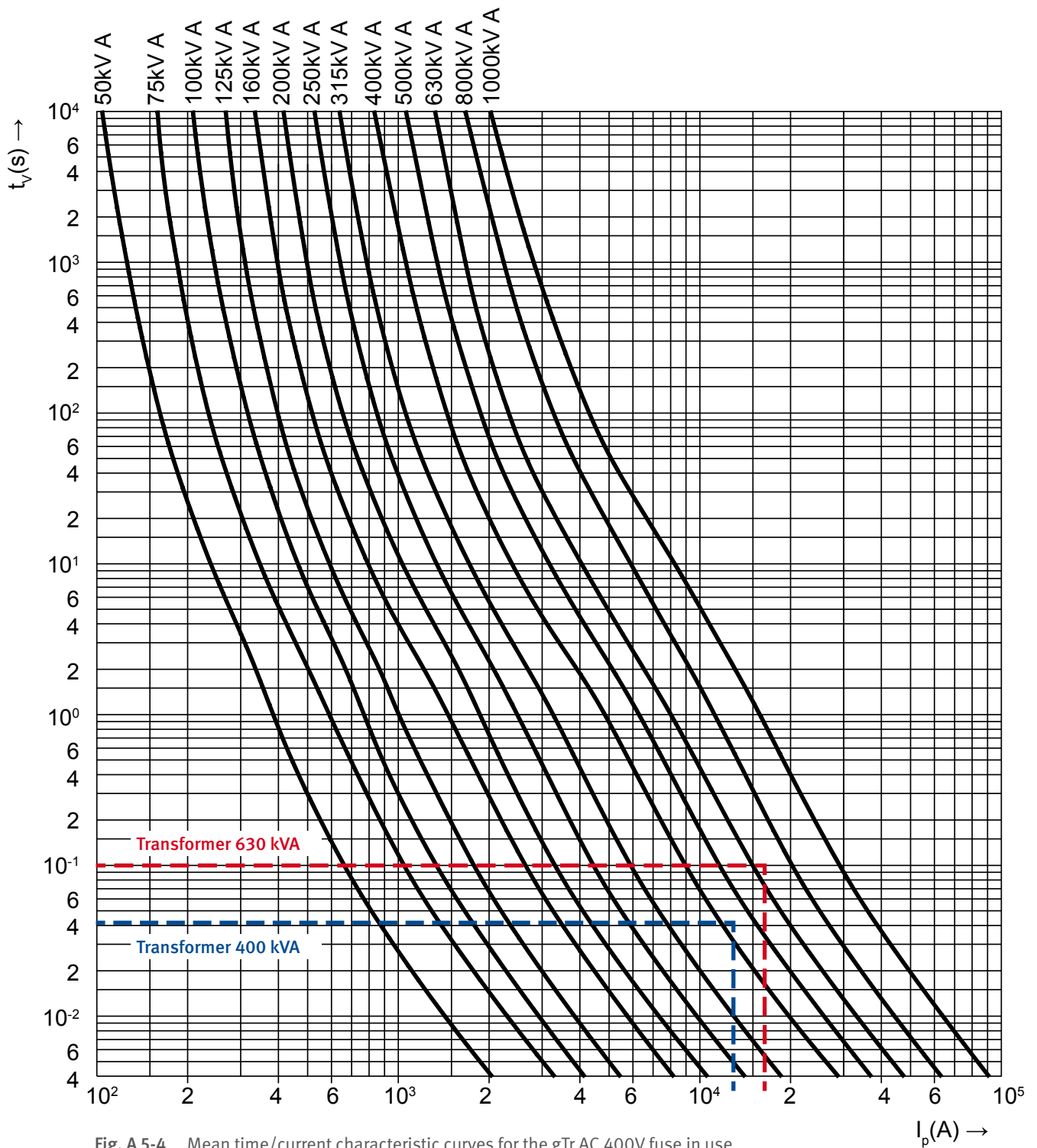

Fig. A 5-4 Mean time/current characteristic curves for the gTr AC 400V fuse in use

The trip time for this current as derived from the fuse characteristics in Fig. A 5-4 is  $t = 0.113$  s. This time equates to the short-circuit duration  $t_k$ .

Note:

*In practice, the characteristic curve for the actual overcurrent protection device in use should be applied.*



*Step 4: Electric arc power at the workplace*

Using the maximum prospective short-circuit current  $I''_{k3,max}$ , it follows for short-circuit power at the workplace that

$$S''_k = \sqrt{3} \cdot U_{Nn} \cdot I''_{k3,max} = \sqrt{3} \cdot 400 \text{ V} \cdot 24.5 \text{ kA} = 16.97 \text{ MVA}$$

Under worst-case conditions, the maximum possible value for normalized arc power can be determined using the formula. For this example, the computation yields

$$k_{P,max} = 0.36.$$

From this, the electric arc energy  $W_{arc}$  results:

$$W_{arc} = k_P \cdot S''_k \cdot t_k = 0.36 \cdot 16.974 \text{ MVA} \cdot 0.113 \text{ s} = 690.3 \text{ kJ}$$

This energy is the expected value for electric arc energy at workplace 1 in the event of a fault.

*Step 5: Establish the working distance*

The working distance for work on low voltage distribution systems is set at  $a = 300 \text{ mm}$ . This corresponds to the minimum distance between a person's torso and the frontal area of the opened equipment.

*Step 6: Test level for the PPE*

The test levels for PPE under standardized Box test conditions according to VDE 0682-306-1-2 are

$$\text{Arc protection class APC 1: } W_{arc, test\_APC 1} = 168 \text{ kJ}$$

$$\text{Arc protection class APC 2: } W_{arc, test\_APC 2} = 320 \text{ kJ}$$

*Step 7: Transmission factor, PPEaA protection level*

When working on low voltage distribution systems in transformer stations, it should be assumed that large-scale installations will be used with spatial limitations primarily due to a rear wall structure. A transmission factor of  $k_T = 1.5$  is assumed at this location. Using a working distance of  $a = 300 \text{ mm}$ , it follows for equivalent arc energy that

$$W_{arc, prot} = k_T \cdot \left( \frac{a}{300 \text{ mm}} \right)^2 \cdot W_{arc, test} = 1.5 \cdot \left( \frac{300 \text{ mm}}{300 \text{ mm}} \right)^2 \cdot W_{arc, test}$$

$$W_{arc, prot\_APC 1} = 252 \text{ kJ with Arc protection class APC 1}$$

$$W_{arc, prot\_APC 2} = 480 \text{ kJ with Arc protection class APC 2}$$

*Step 8: Selection of Arc protection class*

$$W_{arc} = 690.3 \text{ kJ} > W_{arc, prot\_APC 2} = 480 \text{ kJ applies.}$$

The expected electric arc energy is greater than the protection level  $W_{arc, prot\_APC 2}$  of PPEaA in the Arc protection class APC 2. In this case, proceed with the Risk assessment in Phase 4.

Execution of the required work steps will yield the results below (refer to Table A 5-1).

*Phase 4: Implement further measures towards reducing electric arc energy and the probability of injury due to electric fault arcing.*

Suitable measures for reducing arc energy and the probability of injury due to electric fault arcing are not possible for the installation and the work situation in question. Therefore, proceed with Phase 5.

**Table A 5-1** Results of the calculations for  $W_{arc}$  and  $W_{arc, prot}$  for Example 5.1 (630 kVA transformer station)

<b>Work location</b>	630 kVA Low voltage distribution system	Prepared by:	John Doe	
<b>Work order</b>	Connection/disconnection of output circuitry, measurement and testing or cleaning tasks	Date:	29 Nov. 2019	
<b>Calculation</b>		Parameter	Result (worst-case)	Result with a precise calculation according to [21]
Network parameter	Nominal voltage	$U_{Nn}$	400V	
Equipment geometry	Conductor spacing	$d$	60 mm	
Short-circuit current calculation	Max. short-circuit current	$I''_{k3,max}$	24.5 kA	
	Min. short-circuit current	$I''_{k3,min}$	21.6 kA	
	$R/X$ ratio	$R/X$	0.27	
Current limitation		$k_B$	0.5	0.633
Minimum fault current	$I_{k, arc} = k_B \cdot I''_{k3,min}$	$I_{k, arc} =$	10.8 kA	13.67 kA
Trip time for the overcurrent protection device (circuit breaker set value/ Trip time from the protection fuse characteristics)		$t_k$	0.113 s	0.045 s
Short-circuit power	$S''_k = \sqrt{3} \cdot U_{Nn} \cdot I''_{k3,max}$	$S''_k =$	16.97 MVA	
Normalized arc power	$k_p = \frac{0.29}{(R/X)^{0.17}}$	$k_p =$	0.36	0.338
Electric arc power	$P_{arc} = k_p \cdot S''_k$	$P_{arc} =$	6.1 MW	5.7 MW
Electric arc energy (expected value)	$W_{arc} = k_p \cdot S''_k \cdot t_k$	$W_{arc} =$	690.3 kJ	258 kJ
Working distance		$a$	300 mm	
Standardized PPE test level		$W_{arc, test\_APC 2} =$	320 kJ	
		$W_{arc, test\_APC 1} =$	168 kJ	
Transmission factor		$k_T$	1.5	
PPEaA protection level at the point of arcing	$W_{arc, prot} = k_T \cdot \left(\frac{a}{300\text{ mm}}\right)^2 \cdot W_{arc, test}$	$W_{arc, prot\_APC 2} =$	480 kJ	
		$W_{arc, prot\_APC 1} =$	252 kJ	
<b>Comparison</b>		$W_{arc} < W_{arc, prot\_APC 2}$	NO	YES
		$W_{arc} < W_{arc, prot\_APC 1}$	NO	NO
<b>Calculation results:</b>			<b>Isolaton or further measures</b>	<b>APC 2</b>

*Phase 5: Estimate the probability of occurrence and the severity of injury due to electric fault arcing after the adopted measures have been implemented. Evaluate the residual risk and make a decision (Risk matrix)*

In this phase, the potential severity of damage (severity of injury) and the probability of injury due to electric fault arcing are estimated in order that residual risk can be determined.

*Estimation of the severity of injury*

It is assumed in this example that the calculation (according to Section 4) for the working conditions being considered will yield the following results:

Protection level for PPEaA APC 2:  $W_{\text{arc, prot}} = 480 \text{ kJ}$  ( $k_T = 1.5$ ;  $a = 30 \text{ cm}$ )

Arc energy:  $W_{\text{arc}} = 690.3 \text{ kJ}$

The relationship  $W_{\text{arc}} / W_{\text{arc, prot}} = 1.44$  results in an anticipated severity of injury designated as „Reversible injury“ according to Table A 4-1.

*Estimation of the probability of injury*

**Table A 5-2** Estimation of the probability of injury for 5.1

	Designation	Evaluation points	Explanation
a)	Type/condition of equipment	4 ... Unlikely	Open construction in a self-contained electrical operating facility.  An evaluation of condition through visual inspection shows the installation in a properly maintained and clean state
b)	Technical measures	2 ... Conceivable, but very unlikely	The use of bypass-resistant equipment (live working tools; voltage tester, NH fuse handle with sleeve)
c)	Organizational measures	2 ... Conceivable, but very unlikely	Description of the organizational measures Application of operational rules: Work and operating instructions are available Qualification of personnel: The deployment of qualified personnel for these tasks (qualified electricians)
d)	Personal measures	2 ... Conceivable, but very unlikely	The use of PPEaA in the Arc protection class APC 2, the use of NH fuse handle with sleeve
e)	Statistical influencing factors	4 ... Unlikely	Limited space in critical areas: well-arranged structural design; critical areas are clearly identifiable  Frequency and duration of work activities in areas where PPEaA protection in the Arc protection class APC 2 is not available: limited to removal of NH fuse-links – short work duration  Possible additional protective effectiveness through the use of long-sleeved, flame-resistant undergarments: no  Findings from statistically sound and comparable electric arc incidents in the past: Knowledge known about electric arc incidents
f)	Ergonomic influencing factors	2 ... Conceivable, but very unlikely	Experiences gained within the company through the use of different PPEaA or tools: PPEaA and the tools for working on live components were selected together with the participation of affected personnel
	<b>Summation:</b>	16 falls in the range (10 to 19)	<b>Result: The anticipated probability of injury due to electric arcing can be termed „Conceivable, but very unlikely“</b>

	Probability of injury (evaluation points)	1 (0 to 9)	2 (10 to 19)	3 (20 to 30)	4 (31 to 45)	5 (46 to 60)
Severity of damage (Severity of injury)		Practically impossible	Conceivable, but very unlikely	Unlikely	Seldom	Occasional to frequent
1	Slight injury					
2	Reversible injury		APC 2			
3	Irreversible injury					
4	Fatal injury					

Fig. A 5-5 Application of the Risk matrix for Example 5.1

A Risk assessment yielding a Severity of injury  $W_{arc} / W_{arc, prot} = 1.3$  „Reversible injury“ and the Probability of occurrence at 16 points „Conceivable, but very unlikely“ places the results in the green section of the Risk matrix (Fig. A 5-5). It is therefore permissible to perform the work tasks with PPEaA in the Arc protection class APC 2 on the basis of the evaluation approaches adopted.

In the case of a station with a 400 kVA transformer (short-circuit voltage 4 %; NH fuse 400 kVA gTr AC 400 V), the prospective short-circuit current - under otherwise similar conditions as above – will fall within the range  $I''_{k3} = 12.7$  to 14.1 kA.

The  $R/X$  ratio equals 0.27. A current-time curve for the NH fuse (Fig. A 5-4) for  $k_B = 0.5$  and  $I_{k, arc} = 6.9$  kA results in a short-circuit duration of  $t_k = 0.04$  s. The short-circuit power equals  $S''_k = 10.8$  MVA. A normalized arc power of  $k_p = 0.356$  results in an electric arc power of  $P_{arc} = 3.8$  MW and an expected value of electric arc energy at  $W_{arc} = 152$  kJ. The same working distance  $a = 300$  mm and the same transmission relationship ( $k_T = 1.5$ ) means that PPEaA in the Arc protection class APC 1 will be required.

Refer to Table A 5-3 for the results of the calculation.

**Table A 5-3** Results of the calculations for  $W_{\text{arc}}$  and  $W_{\text{arc, prot}}$  for Example 5.1 (400 kVA transformer station)

<b>Work location</b>	400 kVA Low voltage distribution system	Prepared by:	John Doe	
<b>Work order</b>	Connection/disconnection of output circuitry, measurement and testing or cleaning tasks	Date:	29 Nov. 2019	
<b>Calculation</b>		Parameter	Result (worst-case)	Result with a precise calculation according to [21]
Network parameter	Nominal voltage	$U_{\text{Nn}}$	400V	
Equipment geometry	Conductor spacing	$d$	60 mm	
Short-circuit current calculation	Max. short-circuit current	$I''_{\text{k}3,\text{max}}$	15.5 kA	
	Min. short-circuit current	$I''_{\text{k}3,\text{min}}$	13.7 kA	
	$R/X$ ratio	$R/X$	0.30	
Current limitation		$k_{\text{B}}$	0.5	0.64
Minimum fault current	$I_{\text{k, arc}} = k_{\text{B}} \cdot I''_{\text{k}3,\text{min}}$	$I_{\text{k, arc}} =$	6.9 kA	8.8 kA
Trip time for the overcurrent protection device (circuit breaker set value/ Trip time from the protection fuse characteristics)		$t_{\text{k}}$	0.04 s	0.02 s
Short-circuit power	$S''_{\text{k}} = \sqrt{3} \cdot U_{\text{Nn}} \cdot I''_{\text{k}3,\text{max}}$	$S''_{\text{k}} =$	10.8 MVA	
Normalized arc power	$k_{\text{p}} = \frac{0.29}{(R/X)^{0.17}}$	$k_{\text{p}} =$	0.356	0.326
Electric arc power	$P_{\text{arc}} = k_{\text{p}} \cdot S''_{\text{k}}$	$P_{\text{arc}} =$	3.8 MW	3.5 MW
Electric arc energy (expected value)	$W_{\text{arc}} = k_{\text{p}} \cdot S''_{\text{k}} \cdot t_{\text{k}}$	$W_{\text{arc}} =$	152.0 kJ	122.7 kJ
Working distance		$a$	300 mm	
Standardized PPE test level		$W_{\text{arc, test\_APC 2}} =$	320 kJ	
		$W_{\text{arc, test\_APC 1}} =$	168 kJ	
Transmission factor		$k_{\text{T}}$	1.5	
PPEaA protection level at the point of arcing	$W_{\text{arc, prot}} = k_{\text{T}} \cdot \left(\frac{\alpha}{300\text{ mm}}\right)^2 \cdot W_{\text{arc, test}}$	$W_{\text{arc, prot\_APC 2}} =$	480 kJ	
		$W_{\text{arc, prot\_APC 1}} =$	252 kJ	
<b>Comparison</b>		$W_{\text{arc}} < W_{\text{arc, prot\_APC 2}}$	YES	YES
		$W_{\text{arc}} < W_{\text{arc, prot\_APC 1}}$	YES	YES
<b>Calculation results:</b>			<b>APC 1</b>	<b>APC 1</b>

## A 5.2 Example 5.2: Low voltage cable (Work location 2)

Work is frequently carried out on cable sleeves in the cable network (refer to Fig. A 5-6). Work location 2 in this example (cable sleeve after approx. 100 m network cable) as depicted in Fig. 5-1. The level of fault current and electric arc energy is greatly dependent on the distance between the work location and the network supply station (transformer) and, for this reason, on the length of the corresponding network cable.



Fig. A 5-6  
Working on a cable sleeve

In this example, the work location is being fed through a network cable from a 630 kVA transformer station. The NH fuse in the supplying station's cable branch is decisive for breaking the electric fault arc. In this context, an NH 250 A full-range line fuse is used with operating class gG or gL AC 400 V. The current-time curve is depicted in Fig. A 5-7.

### Risk Assessment

*Phase 1: Is there a principle danger of exposure to persons due to electric arcing?*

- Yes
- Work tasks are performed that require physical contact with live conductors, on which electric arcing can occur.

*Phase 2: Base evaluation of the electric arc hazard for the work task or the working environment. Is a calculation required?*

- Yes
- None of the requirements listed in Section 1, in which the use of PPEaA can be dispensed with, have been fulfilled.

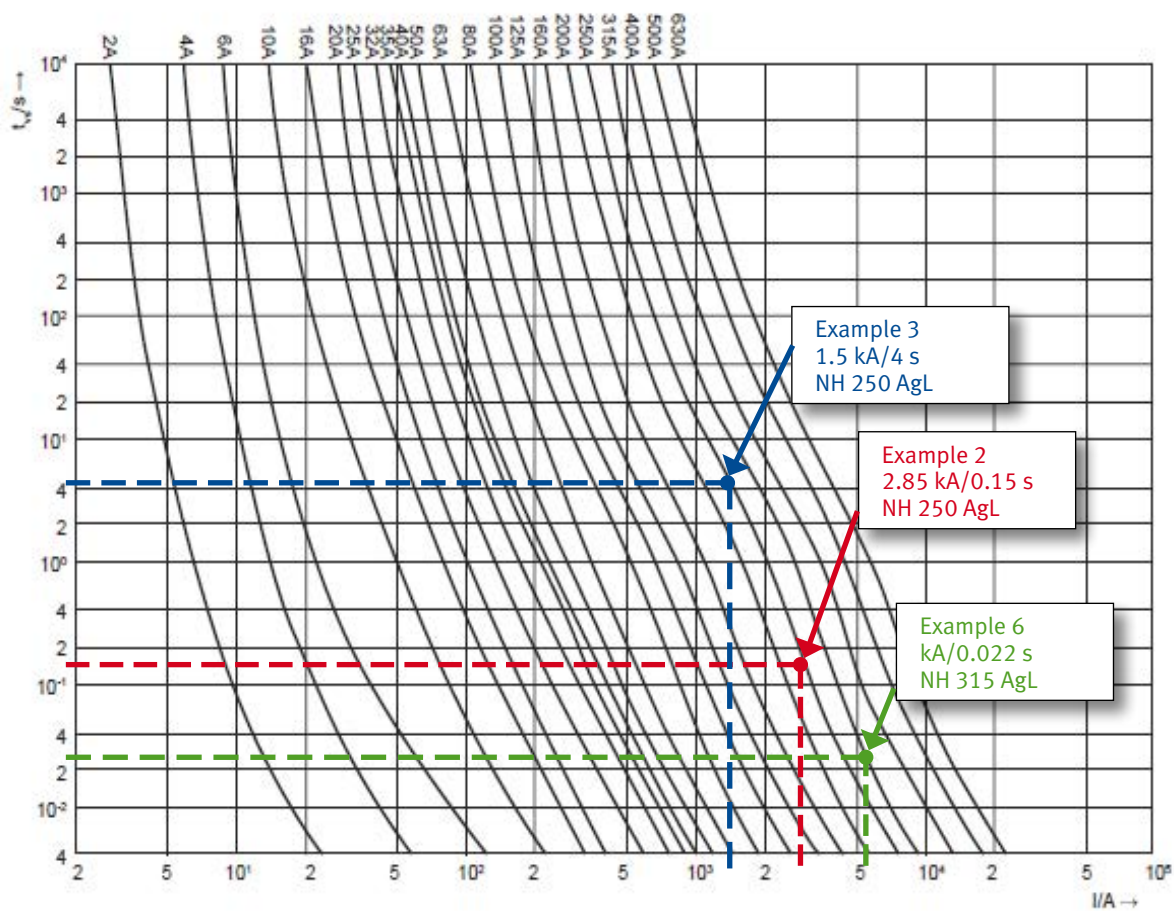

Fig. A 5-7 Mean time/current characteristic curves for the NH gL/gG AC 400 V line protection fuse being considered

Phase 3: Apply the calculation procedure: Determine  $W_{arc}$ ,  $W_{arc, prot}$ !  
 Execution of the required work steps will yield the results below.

**Table A 5-4** Results of the calculations for  $W_{arc}$  and  $W_{arc, prot}$  for Example 5.2 (cable network sleeves)

<b>Work location</b>	Cable troughs	Prepared by:	John Doe	
<b>Work order</b>	Sleeve installation	Date:	29 Nov. 2019	
<b>Calculation</b>		Parameter	Result (worst-case)	Result with a precise calculation according to [21]
Network parameter	Nominal voltage	$U_{Nn}$	400V	
Equipment geometry	Conductor spacing	$d$	45 mm	
Short-circuit current calculation	Max. short-circuit current	$I''_{k3,max}$	8.3 kA	
	Min. short-circuit current	$I''_{k3,min}$	7.5 kA	
	R/X ratio	$R/X$	1.3	
Current limitation		$k_B$	0.5	0.57
Minimum fault current	$I_{k, arc} = k_B \cdot I''_{k3,min}$	$I_{k, arc} =$	3.7 kA	4.3 kA
Trip time for the overcurrent protection device (circuit breaker set value/ Trip time from the protection fuse characteristics)		$t_k$	0.107 s	0.049 s
Short-circuit power	$S''_k = \sqrt{3} \cdot U_{Nn} \cdot I''_{k3,max}$	$S''_k =$	5.8 MVA	
Normalized arc power	$k_p = \frac{0.29}{(R/X)^{0.17}}$	$k_p =$	0.28	0.24
Electric arc power	$P_{arc} = k_p \cdot S''_k$	$P_{arc} =$	1.6 MW	1.4 MW
Electric arc energy (expected value)	$W_{arc} = k_p \cdot S''_k \cdot t_k$	$W_{arc} =$	170.6 kJ	68.9 kJ
Working distance		$a$	300 mm	
Standardized PPE test level		$W_{arc, test\_APC 2} =$	320 kJ	
		$W_{arc, test\_APC 1} =$	168 kJ	
Transmission factor		$k_T$	1.9	
PPEaA protection level at the point of arcing	$W_{arc, prot} = k_T \cdot \left(\frac{a}{300\text{mm}}\right)^2 \cdot W_{arc, test}$	$W_{arc, prot\_APC 2} =$	608 kJ	
		$W_{arc, prot\_APC 1} =$	319 kJ	
<b>Comparison</b>		$W_{arc} < W_{arc, prot\_APC 2}$	YES	YES
		$W_{arc} < W_{arc, prot\_APC 1}$	YES	YES
<b>Calculation results:</b>			<b>APC 1</b>	<b>APC 1</b>

The work under consideration at Work location 2 (cable sleeves) according to the estimation in Section 3 and with the precise calculation requires PPEaA in the Arc protection class APC 1.



### A 5.3 Example 5.3: House junction box (Work location 3)

The replacement of a house junction box is often associated with work on live equipment (Fig. A 5-8; inside/outside). Such an example in Work location 3 is considered in Fig. A 5-1. Energy is once again supplied to the work location from an upstream network station with a 630 kVA transformer. In contrast to Example 2, the short-circuit current is significantly less because the house connection cables have only comparatively small cross-sections. The house connection cable in the example has a length of approx. 15 m.

The branch fuse in the upstream cable distribution cabinet is decisive for a short-circuit shutdown; in this case, an NH 250 A fuse is used with operating class gG AC 400 V.



Fig. A 5-8  
Working on a  
house junction box

#### Risk assessment of the planned activities

*Phase 1: Is there a principle danger of exposure to persons due to electric arcing?*

- Yes.
- Work tasks are performed that require physical contact with open live installation, on which electric arcing can be initiated.

*Phase 2: Initial evaluation of electric arc energy associated with the scope of activity or workplace. Is a calculation required?*

- Yes.
- None of the requirements listed in Section 1, in which the use of PPEaA can be dispensed with, have been fulfilled.

*Phase 3: Apply the calculation methodology: Determine  $W_{arc}$ ,  $W_{arc, prot}$ !*

Execution of the required work steps will yield the results below (refer to Table A 5-5).

Examples

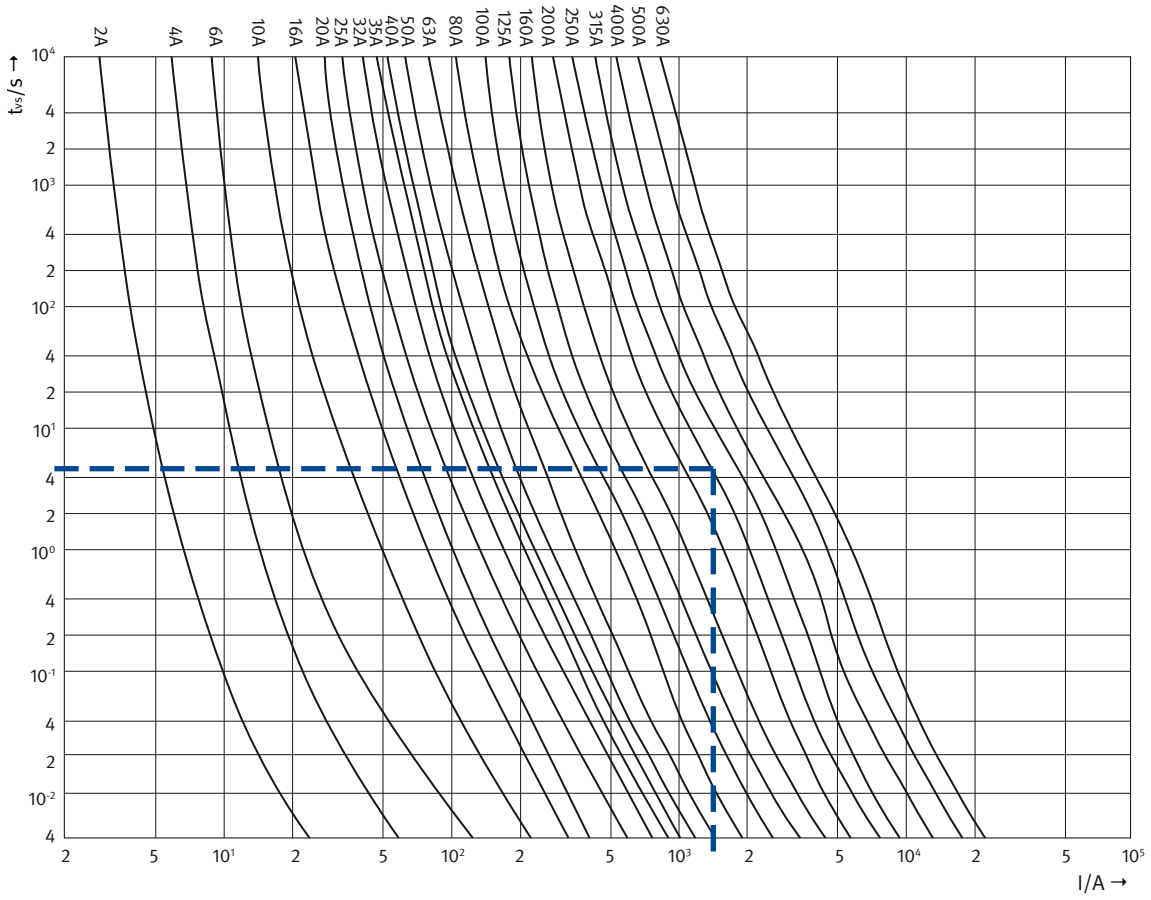

Fig. A 5-9 Mean time/current characteristic curves for the NH gL/gG AC 400V line protection fuse being considered

**Table A 5-5** Results of the calculations for  $W_{\text{arc}}$  and  $W_{\text{arc, prot}}$  for Example 5.3 (open house junction box)

Work location		Prepared by: John Doe		
Work order		Date: 29 Nov. 2019		
Calculation		Parameter	Result (worst-case)	Result with a precise calculation according to [21]
Network parameter	Nominal voltage	$U_{\text{Nn}}$	400V	
Equipment geometry	Conductor spacing	$d$	45 mm	
Short-circuit current calculation	Max. short-circuit current	$I''_{\text{k}3,\text{max}}$	3.4 kA	
	Min. short-circuit current	$I''_{\text{k}3,\text{min}}$	3.0 kA	
	$R/X$ ratio	$R/X$	2.0	
Current limitation		$k_{\text{B}}$	0.5	0.554
Minimum fault current	$I_{\text{k, arc}} = k_{\text{B}} \cdot I''_{\text{k}3,\text{min}}$	$I_{\text{k, arc}} =$	1.5 kA	1,66 kA
Trip time for the overcurrent protection device (circuit breaker set value/ Trip time from the protection fuse characteristics)		$t_{\text{k}}$	1.0 s*	1.0 s*
Short-circuit power	$S''_{\text{k}} = \sqrt{3} \cdot U_{\text{Nn}} \cdot I''_{\text{k}3,\text{max}}$	$S''_{\text{k}} =$	2.353 MVA	
Normalized arc power	$k_{\text{p}} = \frac{0.29}{(R/X)^{0.17}}$	$k_{\text{p}} =$	0.26	0,24
Electric arc power	$P_{\text{arc}} = k_{\text{p}} \cdot S''_{\text{k}}$	$P_{\text{arc}} =$	0,61 MW	0.56 MW
Electric arc energy (expected value)	$W_{\text{arc}} = k_{\text{p}} \cdot S''_{\text{k}} \cdot t_{\text{k}}$	$W_{\text{arc}} =$	607 kJ	565 kJ
Working distance		$a$	300 mm	
Standardized PPE test level		$W_{\text{arc, test\_APC 2}} =$	320 kJ	
		$W_{\text{arc, test\_APC 1}} =$	168 kJ	
Transmission factor		$k_{\text{T}}$	1.0	
PPEaA protection level at the arc location	$W_{\text{arc, prot}} = k_{\text{T}} \cdot \left(\frac{a}{300\text{mm}}\right)^2 \cdot W_{\text{arc, test}}$	$W_{\text{arc, prot\_APC 2}} =$	320 kJ	
		$W_{\text{arc, prot\_APC 1}} =$	168 kJ	
Comparison		$W_{\text{arc}} < W_{\text{arc, prot\_APC 2}}$	NO	NO
		$W_{\text{arc}} < W_{\text{arc, prot\_APC 1}}$	NO	NO
Calculation results:			Isolation or further measures	Isolation or further measures

\* Referencing the current-time curve (Fig. A 5-10) results in a trip time  $t > 1$  s, so it can be assumed that the maximum time relevant to the exposure equates to  $t_{\text{k}} = 1$  s (also refer to the remarks at the end of Sec. 4.2.2).

#### Phase 4: Implement further measures towards reducing electric arc energy and the probability of injury due to electric fault arcing.

It can be seen from the results in the example that PPEaA in the Arc protection class APC 2 is not adequate for work on a house junction box. The high expected value of electric arc energy is brought about by a long short-circuit duration, which results in a long period of exposure.

In order to facilitate work in this case, for example,

- overcurrent protection devices guaranteeing defined and sufficiently rapid shutdown characteristics must be used or
- compliance with an adequate minimum distance must be required or
- PPEaA must be tested for greater levels of incident energy

The option mentioned first will be singled out for consideration below. For this, it must be ensured that the NH 250 A gG branch fuse present in the network supply station’s cable branch is replaced with a safe-work fuse with a low rated current and/or with fast-acting or super-fast-acting operating characteristics for the duration of the work task. This means that, prior to beginning and subsequent to completing the work task, a fuse replacement will be necessary. If an NH 160 A safe-work fuse is used with an operating class aR (fast-acting: üf2; very-fast-acting: üf1; super-fast-acting: üf01; hyper-fast-acting: üf02), a current-limiting shutdown will result in any event. Regarding the calculations in this context, a short-circuit duration of  $t_k = 0.01$  s is to be applied. An NH 160 A aR/690V – üf01 fuse is used for this example, whereby a trip time of 6.87 ms results.

**Table A 5-6** Results of the calculations for  $W_{arc}$  and  $W_{arc, prot}$  for Example 5.3 when using an safe-work fuse (open house junction box)

<b>Work location</b>		Prepared by: John Doe		
<b>Work order</b>		Date: 29 Nov. 2019		
Calculation		Parameter	Result (worst-case)	Result with a precise calculation according to [21]
Network parameter	Nominal voltage	$U_{Nn}$	400V	
Equipment geometry	Conductor spacing	$d$	45 mm	
Short-circuit current calculation	Max. short-circuit current	$I''_{k3,max}$	3.4 kA	
	Min. short-circuit current	$I''_{k3,min}$	3.0 kA	
	R/X ratio	$R/X$	2.0	
Current limitation		$k_B$	0.5	0.554
Minimum fault current	$I_{k, arc} = k_B \cdot I''_{k3,min}$	$I_{k, arc} =$	1.5 kA	1.66 kA
Trip time for the overcurrent protection device (circuit breaker set value/ Trip time from the protection fuse characteristics)		$t_k$	0.01 s	0.01 s
Short-circuit power	$S''_k = \sqrt{3} \cdot U_{Nn} \cdot I''_{k3,max}$	$S''_k =$	2.353 MVA	
Normalized arc power	$k_p = \frac{0.29}{(R/X)^{0.17}}$	$k_p =$	0.26	0.24
Electric arc power	$P_{arc} = k_p \cdot S''_k$	$P_{arc} =$	0.61 MW	0.56 MW
Electric arc energy (expected value)	$W_{arc} = k_p \cdot S''_k \cdot t_k$	$W_{arc} =$	6.1 kJ	5.2 kJ
Working distance		$a$	300 mm	
Standardized PPE test level		$W_{arc, test\_APC\ 2} =$	320 kJ	
		$W_{arc, test\_APC\ 1} =$	168 kJ	
Transmission factor		$k_T$	1.0	
PPEaA protection level at the arc location	$W_{arc, prot} = k_T \cdot \left(\frac{a}{300\text{ mm}}\right)^2 \cdot W_{arc, test}$	$W_{arc, prot\_APC\ 2} =$	320 kJ	
		$W_{arc, prot\_APC\ 1} =$	168 kJ	
<b>Comparison</b>		$W_{arc} < W_{arc, prot\_APC\ 2}$	YES	YES
		$W_{arc} < W_{arc, prot\_APC\ 1}$	YES	YES
<b>Calculation results:</b>			<b>APC 1</b>	<b>APC 1</b>

The calculation reveals that the expected arc energy is less than 50 kJ. Therefore, specific PPEaA is not required for the work task under consideration. An outfit of customary work clothing comprised of long-sleeved outer clothing and long pants is sufficient. When installing the safe-work fuse, however, bear in mind that the use of PPEaA (APC 1 or APC 2) will be required.

### A 5.4 Example 5.4: Electrical installation behind the house junction box (Work location 4)

When work is performed on live components or in the vicinity of live components in an electrical household installation (400 V), which is fuse-protected with a maximum rated current of 63 A, an outfit of customary work clothing comprised of long-sleeved outer clothing and long pants is sufficient (refer to Scope of application).

Note:

For the sake of completeness, the example specified here is taken from the 1st Edition of this DGVU Information (issued October 2012). Calculations from the 1st Edition reveal that the estimated values for  $W_{\text{arc}}$  are significantly below (factor >27) the protection level afforded by PPEaA in the Arc protection class APC 1.



Fig. A 5-10  
Working behind the house  
supply system

#### Risk assessment of the planned activities

*Phase 1: Is there a principle danger of exposure to persons due to electric arcing?*

- Yes
- An electric arc incident can occur when working on distribution systems, such as when replacing a live electricity meter.

*Phase 2: Initial evaluation of electric arc energy associated with the scope of activity or workplace. Is a calculation required?*

- No
- **When working on low voltage installations**, PPEaA can be dispensed with in the following situations:
  - When working on measuring, control and regulation equipment with upstream electric circuit protection up to 25 A.
    - not applicable
  - When working on electrical circuitry with nominal voltages up to 400 V with upstream protection up to 63 A, insofar as an outfit of customary work clothing comprised of long-sleeved outer clothing and long pants is worn.
    - **applicable**

- When working on electrical circuitry with rated voltages up to 400 V AC and a short-circuit current < 1 kA. (such an electric arc will burn unstably and extinguish immediately.)  
.....→ not applicable

### A 5.5 Example 5.5: Removal of NH fuse-links

A meter installer's field of work can encompass work areas associated with different electric arc hazards:

- Working on equipment (meter) behind the house service fuse (compare the example for Work location 4):  
These activities comprise tasks, such as checking voltage and replacing meters (in a voltage-free or a live state). Depending on the computed results, PPEaA in the Arc protection class APC 1 is sufficient for this.
- Work on an opened house junction box; (compare the example for Work location 3):  
When preparing for working on a meter, the service fuse must be removed or reinstalled, where applicable. Depending on the computed results, the calculated protection level for PPEaA in the Arc protection class APC 1 will be exceeded ( $W_{\text{arc}} / W_{\text{arc, prot}} = 1.3$ ).

Meter installers are usually equipped with PPEaA in the Arc protection class APC 1. This raises the question as to whether it is absolutely essential to be equipped with PPEaA in the Arc protection class APC 2 for the removal and installation of service fuses, or whether these activities can be carried out with PPEaA in the Arc protection class APC 1?



Fig. A 5-11  
Removal and installation of  
NH fuse-links in a house junc-  
tion box

## Risk assessment of the planned activities

*Phase 1: Is there a principle danger of exposure to persons due to electric arcing?*

- Yes.
- Work tasks are performed that require physical contact with open live installation.

*Phase 2: Initial evaluation of electric arc hazard associated with the scope of activity or workplace. Is a calculation required?*

- Yes.
- None of the requirements listed in Section 1, in which the use of PPEaA can be dispensed with, have been fulfilled.

*Phase 3: Apply the calculation methodology: Determine  $W_{\text{arc}}$ ,  $W_{\text{arc, prot}}$ !*

Calculating for  $W_{\text{arc}}$  yields 607 kJ (compare Table A 5-5, House junction box). On the basis of a working distance of  $a = 500$  mm, the protection level for PPEaA in the Arc protection class APC 1 equals 467 kJ (with  $k_T = 1$ ).

A working distance of 500 mm has been assumed because this task requires working with an almost completely outstretched arm.

Consequently,  $W_{\text{arc}}$  exceeds the protection level afforded by Arc protection class APC 1 by a factor of 1.3.

*Phase 4: Implement further measures towards reducing electric arc energy and the probability of injury due to electric fault arcing.*

A further measure towards reducing the probability of injury due to electric fault arcing would be to employ PPEaA in the Arc protection class APC 2. This estimation will be further considered in Phase 5 in order to investigate whether these activities can also be carried out using PPEaA in the Arc protection class APC 1.

*Phase 5: Estimate the probability of occurrence and the severity of injury due to electric fault arcing after the adopted measures have been implemented. Evaluate the residual risk and make a decision (Risk matrix).*

*Estimation of the severity of injury*

It is assumed in this example that the calculation (according to Section 4) for the working conditions under consideration will yield the following results:

Protection level for APC 1 PPEaA:	$W_{\text{arc, prot}}$	= 467 kJ ( $k_T = 1$ ; $a = 500$ mm)
Arc energy:	$W_{\text{arc}}$	= 607 kJ

The relationship  $W_{\text{arc}} / W_{\text{arc, prot}} = 1.3$  results in an anticipated severity of injury designated as „Reversible injury“ according to Table A 4-2.

*Estimation of the probability of an injury*

**Table A 5-7** Estimation of the probability of injury for 5.5

	Designation	Evaluation points	Explanation
a)	Type/condition of equipment	4 ... Unlikely	Open construction in a self-contained electrical operating facility. An evaluation of condition through visual inspection shows the installation in a properly maintained and clean state
b)	Technical measures	2 ... Conceivable, but very unlikely	The use of bypass-resistant equipment (live working tools; voltage tester, NH fuse handle with sleeve)
c)	Organizational measures	2 ... Conceivable, but very unlikely	Implementation of company rules: Work and operating instructions are available Qualification of personnel: The deployment of qualified personnel for these tasks (qualified electricians)
d)	Personal measures	2 ... Conceivable, but very unlikely	The use of PPEaA in the Arc protection class APC 1, the use of NH fuse handle with sleeve
e)	Statistical influencing factors	4 ... Unlikely	Limited space in critical areas: well-arranged structural design; critical areas are clearly identifiable Frequency and duration of work activities in areas where PPEaA protection in the Arc protection class APC 2 is not available: limited to removal of NH fuse-links – short work duration Possible additional protective effectiveness through the use of long-sleeved, flame-resistant undergarments: no Findings from statistically sound and comparable electric arc incidents in the past: Knowledge known about electric arc incidents
f)	Ergonomic influencing factors	2 ... Conceivable, but very unlikely	Experiences gained within the company through the use of different PPEaA or tools: PPEaA and the tools for working on live components were selected together with the participation of affected personnel
	<b>Summation:</b>	16 falls in the range (10 to 19)	<b>Result: The anticipated probability of injury due to electric arcing can be termed “conceivable, but very unlikely”</b>

	Probability of injury (evaluation points)	1 (0 to 9)	2 (10 to 19)	3 (20 to 30)	4 (31 to 45)	5 (46 to 60)
Severity of damage (Severity of injury)		Practically impossible	Conceivable, but very unlikely	Unlikely	Seldom	Occasional to frequent
1	Slight injury					
2	Reversible injury		<b>APC 1</b>			
3	Irreversible injury					
4	Fatal injury					

**Fig. A 5-12** Application of the Risk matrix for Example 5.5



A Risk assessment yielding a Severity of injury  $W_{\text{arc}} / W_{\text{arc, prot}} = 1.3$  “Reversible injury” and the Probability of occurrence at 16 points “Conceivable, but very unlikely” places the results in the green section of the Risk matrix (Fig. A 5-12). It is therefore permissible to perform the work tasks with PPEaA in the Arc protection class APC 1 on the basis of the evaluation approaches adopted.

### A 5.6 Example 5.6: Industrial distributor

The following example depicts the calculation for a typical configuration behind an NH 315 A gG fuse. Various tasks are carried out behind the NH fuse on the installation in this example (refer to Fig. A 5-13). This ranges from simple adjustments on protection devices and equipment to replacement of the equipment itself. The work location is on the electrotechnical equipment for a cooling unit that lies behind an 86 m long cable.

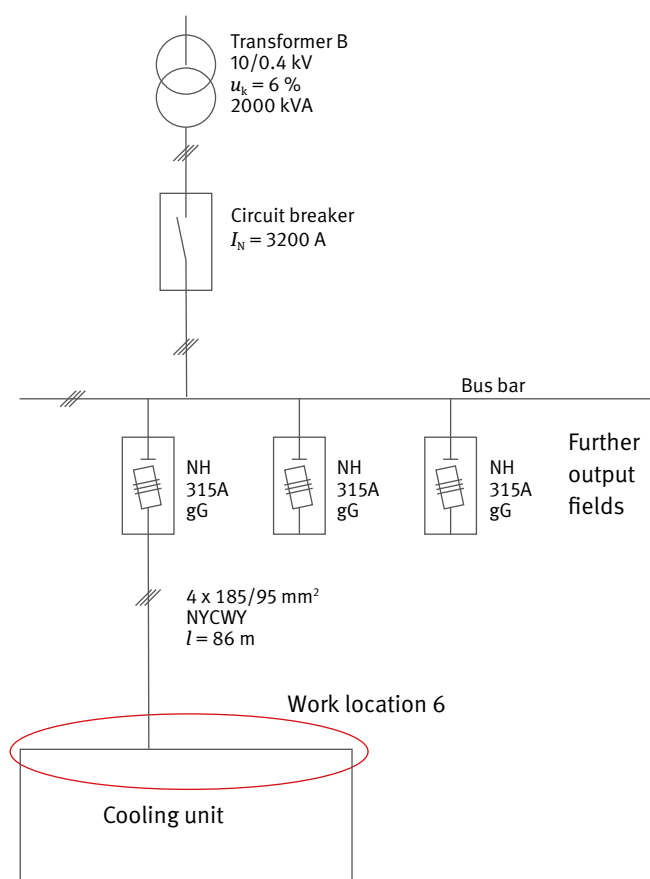

Fig. A 5-13 Industrial installation system overview

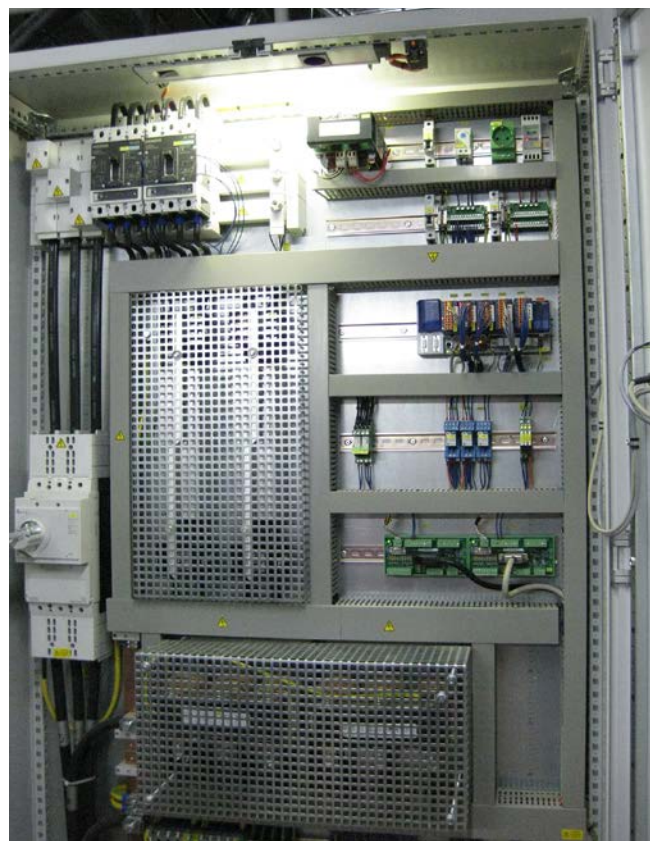

Fig. A 5-14 Industrial low voltage system (cooling unit control cabinet)

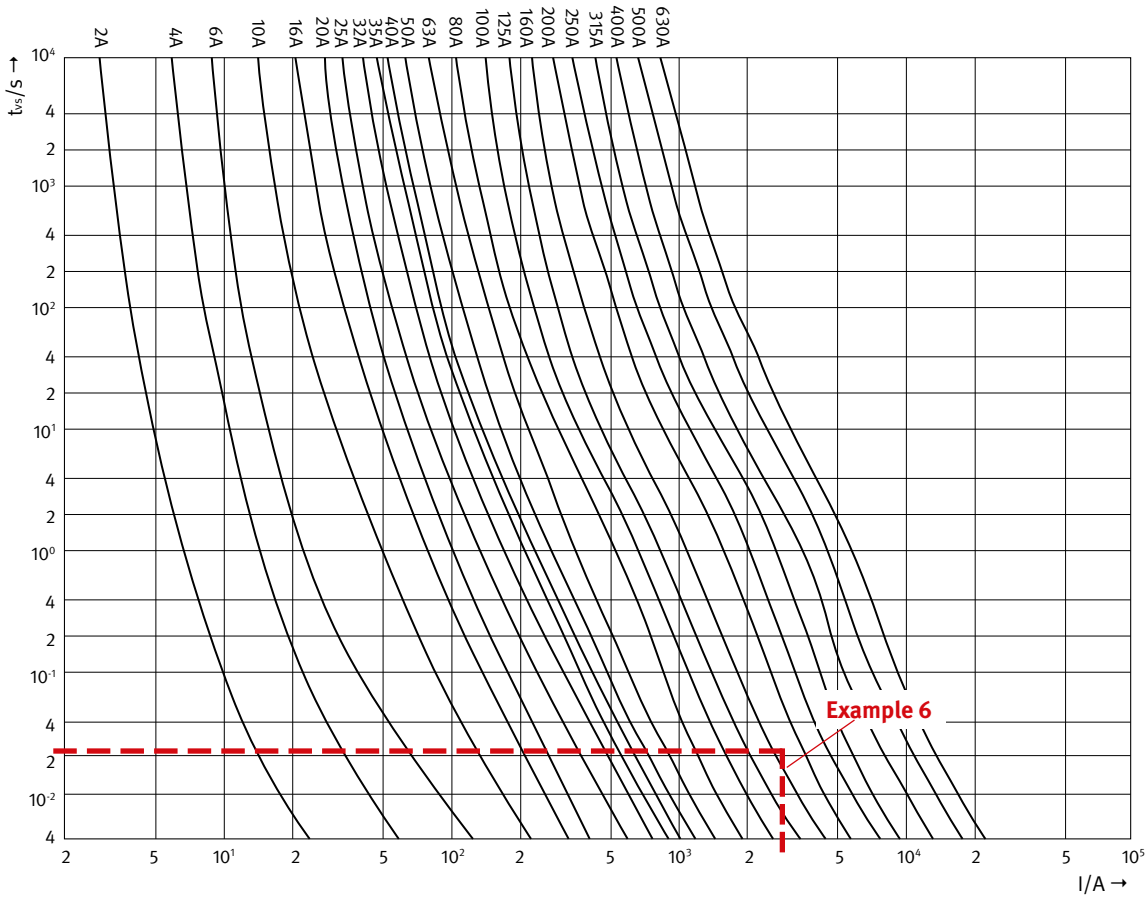

Fig. A 5-15 Mean time/current characteristic curves for the NH gL/gG AC 400V line protection fuse being considered

**Risk assessment of the planned activities**

*Phase 1: Is there a principle danger of exposure to persons due to electric arcing?*

- Yes
- Work is carried out requiring physical contact with open live installation or in the vicinity of live equipment components, on which electric arcing can occur.

*Phase 2: Initial evaluation of electric arc energy associated with the scope of activity or workplace. Is a calculation required?*

- Yes
- None of the requirements listed in Section 1, in which the use of PPEaA can be dispensed with, have been fulfilled.

*Phase 3: Apply the calculation methodology: Determine  $W_{arc}$ ,  $W_{arc, prot}$ !*

Execution of the required work steps will yield the results below (refer to Table A 5-8).

**Table A 5-8** Results of the calculations for  $W_{\text{arc}}$  and  $W_{\text{arc, prot}}$  for Example 5.6 (low voltage industrial equipment)

Work location		Prepared by: John Doe		
Work order		Date: 29 Nov. 2019		
Calculation		Parameter	Result (worst-case)	Result with a precise calculation according to [21]
Network parameter	Nominal voltage	$U_{\text{Nn}}$	400V	
Equipment geometry	Conductor spacing	$d$	20 mm	
Short-circuit current calculation	Max. short-circuit current	$I''_{\text{k}3,\text{max}}$	16.4 kA	
	Min. short-circuit current	$I''_{\text{k}3,\text{min}}$	14.7 kA	
	$R/X$ ratio	$R/X$	0,81	
Current limitation		$k_{\text{B}}$	0.5	0.761
Minimum fault current	$I_{\text{k, arc}} = k_{\text{B}} \cdot I''_{\text{k}3,\text{min}}$	$I_{\text{k, arc}} =$	7.4 kA	11.4 kA
Trip time for the overcurrent protection device (circuit breaker set value/ Trip time from the protection fuse characteristics)		$t_{\text{k}}$	0.013 s	0.01 s
Short-circuit power	$S''_{\text{k}} = \sqrt{3} \cdot U_{\text{Nn}} \cdot I''_{\text{k}3,\text{p,max}}$	$S''_{\text{k}} =$	11.4 MVA	
Normalized arc power	$k_{\text{p}} = \frac{0.29}{(R/X)^{0.17}}$	$k_{\text{p}} =$	0.3	0.17
Electric arc power	$P_{\text{arc}} = k_{\text{p}} \cdot S''_{\text{k}}$	$P_{\text{arc}} =$	3.5 MW	1.9 MW
Electric arc energy (expected value)	$W_{\text{arc}} = k_{\text{p}} \cdot S''_{\text{k}} \cdot t_{\text{k}}$	$W_{\text{arc}} =$	45.2 kJ	19.1 kJ
Working distance		$a$	300 mm	
Standardized PPE test level		$W_{\text{arc, test\_APC 2}} =$	320 kJ	
		$W_{\text{arc, test\_APC 1}} =$	168 kJ	
Transmission factor		$k_{\text{T}}$	1.5	
PPEaA protection level at the arc location	$W_{\text{arc, prot}} = k_{\text{T}} \cdot \left(\frac{a}{300\text{mm}}\right)^2 \cdot W_{\text{arc, test}}$	$W_{\text{arc, prot\_APC 2}} =$	480 kJ	
		$W_{\text{arc, prot\_APC 1}} =$	252 kJ	
Comparison		$W_{\text{arc}} < W_{\text{arc, prot\_APC 2}}$	YES	YES
		$W_{\text{arc}} < W_{\text{arc, prot\_APC 1}}$	YES	YES
Calculation results:			APC 1	APC 1

Note:

With a precise calculation, the characteristic curve for the protection fuse yields a time  $< 10$  ms; the short-circuit duration is therefore established at 10 ms.

The calculation reveals that the expected arc energy is less than  $W_{\text{arc, min}} = 50$  kJ. Therefore, specific PPEaA is not required for the work task under consideration. An outfit of customary work clothing comprised of long-sleeved outer clothing and long pants is sufficient. However, it is recommended that protective clothing in the Arc protection class APC 1 be worn.

### A 5.7 Example 5.7: Switching on systems of older design, not tested for electric fault arcing

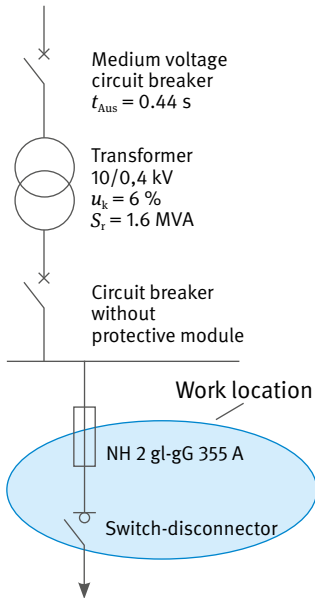

Fig. A 5-16 Equivalent circuit switchgear

Due to the high power demands in the industrial sector, equipment with high levels of short-circuit power are frequently deployed. Common transformer sizes for the transformation of medium to low voltage are 1.0 MVA, 1.6 MVA, 2.0 MVA and 2.5 MVA, and sometimes even as high as 4 MVA. As a consequence, these systems are capable of producing very high short-circuit currents. Relatively long trip times also exist to some extent.

The discussion below considers an exemplary case, in which a control panel (radial network) is isolated so that work can be performed on an underlying distribution system.

At first, the switch-disconnector assigned to the output circuit is actuated from outside by means of a lever (View a). Subsequently, the NH fuse-link is removed (View b) and the voltage-free state is determined (View c).

#### Risk assessment of the planned activities

*Phase 1: Is there a principle danger of exposure to persons due to electric arcing?*

- Yes.
- Resulting from a failure of the switching element and subsequent removal of the NH fuse-link from live installation, the potential for electric arcing cannot be ruled out.

*Phase 2: Initial evaluation of electric arc energy associated with the scope of activity or workplace. Is a calculation required?*

- Yes.
- None of the requirements listed in Section 1, in which the use of PPEaA can be dispensed with, have been fulfilled.



Fig. A 5-17 High-performance switchgear of older design; intended for industrial use



Fig. A 5-18 Opened panel

### A 5.7.1 View a – Opening the load break switch



Fig. A 5-19  
Opening the load break switch with a closed door by means of an operating lever

### Phase 3: Apply the calculation methodology: Determine $W_{arc}$ , $W_{arc, prot}$ !

The calculation in Table A 5-9 reveals that APC 1 classified protective clothing is sufficient for opening the switch-disconnector. The protective properties of the door are not considered in this calculation because they are not quantifiable.

#### Note:

*Arc flash testing on actual switchgear has revealed that doors have significant protective properties. In the event of strong electric arcing, the doors will presumably open and the arc energy will dissipate through the opening that emerges (directivity). For this reason, it makes sense to position one's self in front of the installation so not to occupy the area where the doors will potentially open (stand off to the side). This will contribute to increasing the level of protection afforded the worker. Testing also revealed that the door hinges usually hold, while the opening emerges in the area of the locking mechanism.*

**Table A 5-9** Results of the calculations for  $W_{arc}$  and  $W_{arc, prot}$  for Example 5.7.1 (opening the load break switch)

<b>Work location</b>	Switchgear (older design)	Prepared by:	John Doe	
<b>Work order</b>	Open the load break switch	Date:	29 Nov. 2019	
<b>Calculation</b>		Parameter	Result (worst-case)	Result with a precise calculation according to [21]
Network parameter	Nominal voltage	$U_{Nn}$	400V	
Equipment geometry	Conductor spacing	$d$	20 mm	
Short-circuit current calculation	Max. short-circuit current	$I''_{k3,max}$	36 kA	
	Min. short-circuit current	$I''_{k3,min}$	29 kA	
	$R/X$ ratio	$R/X$	0.12	
Current limitation		$k_B$	0.5	0.9
Minimum fault current	$I_{k, arc} = k_B \cdot I''_{k3,min}$	$I_{k, arc} =$	14.5 kA	26.1 kA
Trip time for the overcurrent protection device (circuit breaker set value/ Trip time from the protection fuse characteristics)		$t_k$	0.01 s	0.01 s
Short-circuit power	$S''_k = \sqrt{3} \cdot U_{Nn} \cdot I''_{k3,max}$	$S''_k =$	24.9 MVA	
Normalized arc power	$k_p = \frac{0.29}{(R/X)^{0.17}}$	$k_p =$	0.42	0.19
Electric arc power	$P_{arc} = k_p \cdot S''_k$	$P_{arc} =$	10.4 MW	4.7 MW
Electric arc energy (expected value)	$W_{arc} = k_p \cdot S''_k \cdot t_k$	$W_{arc} =$	103.7 kJ	47.4 kJ
Working distance		$a$	600 mm	
Standardized PPE test level		$W_{arc, test\_APC 2} =$	320 kJ	
		$W_{arc, test\_APC 1} =$	168 kJ	
Transmission factor		$k_T$	1.9	
PPEaA protection level at the arc location	$W_{arc, prot} = k_T \cdot \left(\frac{a}{300\text{ mm}}\right)^2 \cdot W_{arc, test}$	$W_{arc, prot\_APC 2} =$	2432 kJ	
		$W_{arc, prot\_APC 1} =$	1277 kJ	
<b>Comparison</b>		$W_{arc} < W_{arc, prot\_APC 2}$	YES	YES
		$W_{arc} < W_{arc, prot\_APC 1}$	YES	YES
<b>Calculation results:</b>			<b>APC 1</b>	<b>APC 1</b>

### A 5.7.2 View b – Removal of NH fuse-links



Fig. A 5-20  
Removal of NH fuse-links,  
additional portable separators  
to isolate different potentials

*Phase 3 (View b): Apply the calculation methodology: Determine  $W_{\text{arc}}$ ,  $W_{\text{arc, prot}}$ !*  
Refer to Table A 5-10 for the results of the calculation.

*Phase 4: Implement further measures towards reducing electric arc energy and the probability of injury due to electric fault arcing.*

Suitable measures for reducing arc energy and the probability of injury due to electric fault arcing are not possible for the installation and the work situation in question. Therefore, proceed with Phase 5.

*Phase 5: Estimate the probability of occurrence and the severity of injury due to electric fault arcing after the adopted measures have been implemented. Evaluate the residual risk and make a decision (Risk matrix).*

#### *Estimation of the severity of injury*

It is assumed in this example that the calculation (according to Section 4) for the working conditions being considered will yield the following results:

Protection level for PPEaA APC 2:  $W_{\text{arc, prot\_APC2}} = 1689 \text{ kJ}$  ( $k_T = 1.9$ ;  $a = 500 \text{ mm}$ )  
Arc energy:  $W_{\text{arc}} = 3512 \text{ kJ}$

The relationship  $W_{\text{arc}} / W_{\text{arc, prot}} = 2.1$  results in an anticipated severity of injury designated as “Reversible injury” according to Table A 5-11.

**Table A 5-10** Results of the calculations for  $W_{arc}$  and  $W_{arc, prot}$  for Example 5.7.2 (removal of NH fuse-links)

<b>Work location</b>	Switchgear (older design)	Prepared by: John Doe		
<b>Work order</b>	Remove NH fuse-links	Date: 29 Nov. 2019		
<b>Calculation</b>		Parameter	Result (worst-case)	Result with a precise calculation according to [21]
Network parameter	Nominal voltage	$U_{Nn}$	400V	
Equipment geometry	Conductor spacing	$d$	60 mm	
Short-circuit current calculation	Max. short-circuit current	$I''_{k3,max}$	36 kA	
	Min. short-circuit current	$I''_{k3,min}$	29 kA	
	$R/X$ ratio	$R/X$	0.12	
Current limitation		$k_B$	0.5	0.67
Minimum fault current	$I_{k, arc} = k_B \cdot I''_{k3,min}$	$I_{k, arc} =$	14.75 kA	19.4 kA
Trip time for the overcurrent protection device (circuit breaker set value/ Trip time from the protection fuse characteristics)		$t_k$	0.424 s	0.44 s
Short-circuit power	$S''_k = \sqrt{3} \cdot U_{Nn} \cdot I''_{k3,max}$	$S''_k =$	24.9 MVA	
Normalized arc power	$k_p = \frac{0.29}{(R/X)^{0.17}}$	$k_p =$	0.42	0.32
Electric arc power	$P_{arc} = k_p \cdot S''_k$	$P_{arc} =$	10.4 MW	8.0 MW
Electric arc energy (expected value)	$W_{arc} = k_p \cdot S''_k \cdot t_k$	$W_{arc} =$	4564 kJ	3512 kJ
Working distance		$a$	500 mm	
Standardized PPE test level		$W_{arc, test\_APC 2} =$	320 kJ	
		$W_{arc, test\_APC 1} =$	168 kJ	
Transmission factor		$k_T$	1.9	
PPEaA protection level at the arc location	$W_{arc, prot} = k_T \cdot \left(\frac{a}{300\text{ mm}}\right)^2 \cdot W_{arc, test}$	$W_{arc, prot\_APC 2} =$	1689 kJ	
		$W_{arc, prot\_APC 1} =$	887 kJ	
<b>Comparison</b>		$W_{arc} < W_{arc, prot\_APC 2}$	NO	NO
		$W_{arc} < W_{arc, prot\_APC 1}$	NO	NO
<b>Calculation results:</b>			<b>Isolation or further measures</b>	<b>Isolation or further measures</b>



## Estimation of the probability of injury

**Table A 5-11** Estimation of the probability of injury for 5.7

	Designation	Evaluation points	Explanation
a)	Type/condition of equipment	4 ... Unlikely	Equipment slightly dusty (no conductive deposits); condition assessment by visual inspection
b)	Technical measures	2 ... Conceivable, but very unlikely	The use of bypass-resistant equipment (NH fuse handle with sleeve, mobile separators between the fuse-bases CAT IV voltage tester)
c)	Organizational measures	2 ... Conceivable, but very unlikely	Implementation of company rules: Work and operating instructions are available Qualification of personnel: The deployment of qualified personnel for these tasks - specially trained switching personnel (qualified electricians) Overview circuit diagrams are available and up-to-date
d)	Personal measures	2 ... Conceivable, but very unlikely	The use of PPEaA in the Arc protection class APC 2
e)	Statistical influencing factors	4 ... Unlikely	Limited space in critical areas: well-arranged structural design; critical areas are clearly identifiable Frequency and duration of work activities in areas where PPEaA protection in the Arc protection class APC 2 is not available: Limited to the removal of NH fuse-links – short work duration Findings from statistically sound and comparable electric arc incidents in the past: have not occurred to date while performing the activity in the organizational unit
f)	Ergonomic influencing factors	2 ... Conceivable, but very unlikely	Experiences gained within the company through the use of different PPEaA or tools: PPEaA and the tools for working on live components were selected together with the participation of affected personnel
	<b>Summation:</b>	16 falls in the range (10 to 19)	<b>Result: The anticipated probability of injury due to electric arcing can be termed „conceivable, but very unlikely“</b>

	Probability of injury (evaluation points)	1 (0 to 9)	2 (10 to 19)	3 (20 to 30)	4 (31 to 45)	5 (46 to 60)
Severity of damage (Severity of injury)		Practically impossible	Conceivable, but very unlikely	Unlikely	Seldom	Occasional to frequent
1	Slight injury					
2	Reversible injury		<b>APC 2</b>			
3	Irreversible injury					
4	Fatal injury					

Fig. A 5-21 Application of the Risk matrix for Example 5.7

A Risk assessment yielding a Severity of injury  $W_{arc} / W_{arc, prot} = 2.1$  “Reversible injury” and the Probability of occurrence at 16 points “Conceivable, but very unlikely” places the results in the green section of the Risk matrix (Fig. A 5-21). It is therefore permissible to perform the work tasks with PPEaA in the Arc protection class APC 2 on the basis of the evaluation approaches adopted.

*A 5.7.3 View c – Determine the voltage-free state*



Fig. A 5-22  
Determining a voltage-free state

The voltage-free state must be determined at the conclusion of the isolation process. In the context of Phase 1 of the Risk assessment, it must be assessed as to whether a hazard due to exposure to electric fault arcing exists. For the case at hand, this test is performed using a CAT IV voltage tester with extended tips. These are not necessarily required here, but it is considered standard for companies employing switching personnel because they afford a greater working distance. They are configured with very short metallic tips, whereby a bridging of the potentials between live parts in the case at hand cannot take place. The potential for electric arcing can be thus ruled out, so that determination of the voltage-free state can be done without PPEaA. Yet, because PPEaA was required anyway for the previous work step (Removal of NH fuse-links), it should also be used when carrying out this short process of determining the voltage-free state.

Because APC 2 PPEaA is required for work step b – “Removal of NH fuse-links” it follows that PPEaA will be used for all three work steps. The wearing of PPEaA is ergonomically unproblematic because the duration of the overall work being performed is only 5 to 10 minutes.

## A 5.8 Example 5.8: Working on DC installations (UPS)

### Working on UPS systems

This example deals with work performed on a UPS system (uninterruptible power supply) of 200 kVA (displacement factor  $\cos \varphi = 0.9$ , efficiency factor DC/AC = 0.9) with a high-performance battery in the intermediate circuit of the inverter. The intermediate circuit voltage equals 400 V (refer to Fig. A 5-23).

Based on the output power from the inverter, an end-point voltage of 350 V and a prescribed discharge time (bridging time) of 15 min yields a battery discharge current (maximum battery current) of 571 A. Protection of the battery is provided for through the use of a fuse switch disconnecter with a DC battery fuse NH gR Bat 500 A (500 V, frame size NH3).

The battery is comprised of 100 series connected 4 V battery cells. In the data sheet, the manufacturer specifies an internal resistance of 97.9 m $\Omega$  (0.98 m $\Omega$ /cell), which yields a prospective short-circuit current of  $I_{kDC} = 4.086$  kA.

### Risk assessment of the planned activities

*Phase 1: Is there a principle danger of exposure to persons due to electric arcing?*

- Yes.
- When working on an inverter or in the vicinity of the battery, the potential for electric arcing cannot be ruled out.

*Phase 2: Initial evaluation of electric arc energy associated with the scope of activity or workplace. Is a calculation required?*

- Yes.
- None of the requirements listed in Section 1, in which the use of PPEaA can be dispensed with, have been fulfilled.

#### A 5.8.1 Working in the vicinity of a battery or directly on the battery cells (Work location 1)

*Phase 3: Apply the calculation methodology: Determine  $W_{arc}$ ,  $W_{arc, prot}$ !*

When working in the vicinity of a battery or directly on the battery cells, a conductor spacing of  $d = 30$  mm is assumed when introducing an electric arc short-circuit, which yields a current limiting factor of  $k_B = 0.677$  and an actual fault current (electric arc short-circuit current) of  $I_{k, arc} = 2.76$  kA. Because the work location is not within the protection zone of the NH gR Bat fuse, the most unfavourable case for an exposure time  $t_k = 1$  s must be assumed (maximum exposure time or duration of time, in which a person is able to withdraw from the immediate danger area).

For electric arc power, the iteration calculation yields  $P_{arc} = 358$  kW, which corresponds to a normalized arc power of  $k_p = 0.219$ . With a short-circuit duration of  $t_k = 1000$  ms, the resulting expected value for converted electric arc energy at the work location (fault location) is  $W_{arc} = 358$  kJ.

If electric arc power is calculated with a worst-case estimation (without considering the electrode gap) for the relationship of  $P_{arc} = 0.25 P_K$  with the network parameters for network voltage level, prospective short-circuit current and the short-circuit power at

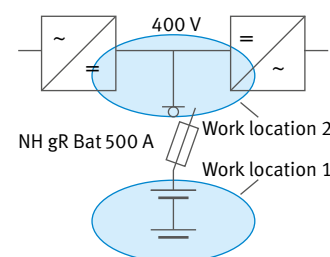

Fig. A 5-23  
Principle circuit diagram for the UPS system for Work locations (fault locations) 1 and 2

$P_K = U_N \cdot I_{kDC}$ , then it follows that  $P_{arc, max} = 0.25 \cdot 1.634 \text{ MVA} = 0.408 \text{ MW}$ . The resulting expected value for arc energy is then  $W_{arc, max} = 408.5 \text{ kJ}$ .

The PPEa protection level is determined from the arc energy test level with consideration given to the transmission relationships and the working distance  $a$ . If one assumes conditions related to the system volume where a rear panel effect primarily exists, which correspond to a transmission factor of  $k_T = 1.5$  and a distance of  $a = 300 \text{ mm}$ , then an PPEa protection level  $W_{arc, prot}$  will result from the test levels  $W_{arc, test}$  conforming to  $W_{arc, prot} = k_T \cdot (a / 300 \text{ mm})^2 \cdot W_{arc, test}$ . For Arc protection class APC 1,  $W_{arc, prot\_APC 1} = 252 \text{ kJ}$  applies, and for Arc protection class APC 2,  $W_{arc, prot\_APC 2} = 480 \text{ kJ}$  applies. It follows then that PPEa in the Arc protection class APC 2 is necessary for the work in question.

The calculations are depicted in the form of work steps in the overview Table A 5-12.

**Table A 5-12** Summary of the example for work on UPS systems at Work location 1

Work location	Working on an inverter	Prepared by:	John Doe
Work order	200 kVA UPS system	Date:	29 Nov. 2019
Calculation		Parameter	Result
Network parameter	Nominal voltage	$U_{Nn}$	400V
Equipment geometry	Conductor spacing	$d$	30 mm
Short-circuit current calculation	Sustained short-circuit current	$I_{kDC}$	4.0 kA
	Time constant $\tau$	$\tau$	0.002 s
Current limitation		$k_B$	0.677
Electric arc current (fault current)	$I_{k, arc (i+1)} = \frac{U_{Nn}}{\frac{(34 + 0.532 \cdot d)}{I_{k, arc (i)}^{0.88}} + \frac{U_{Nn}}{I_{kDC}}}$	$I_{k, arc} =$	2.76 kA
Trip time for the overcurrent protection device (circuit breaker set value/ Trip time from the protection fuse characteristic curve)		$t_k$	1.000 s
Short-circuit power	$P_k = U_{Nn} \cdot I_{kDC}$	$P_k =$	1.6 MW
Electric arc power	$P_{arc} = U_{arc} \cdot I_{k, arc}$	$P_{arc} =$	0.36 MW
Normalized arc power	$k_p = P_{arc} / P_k$	$k_p =$	0.219
Electric arc energy (expected value)	$W_{arc} = P_{arc} \cdot t_k$	$W_{arc} =$	357.46 kJ
Working distance		$a$	300 mm
Standardized PPE test level		$W_{arc, test\_APC 2} =$	320 kJ
		$W_{arc, test\_APC 1} =$	168 kJ
Transmission factor		$k_T$	1.5
PPEa protection level at the point of arcing	$W_{arc, prot} = k_T \cdot \left(\frac{a}{300 \text{ mm}}\right)^2 \cdot W_{arc, test}$	$W_{arc, prot\_APC 2} =$	480 kJ
		$W_{arc, prot\_APC 1} =$	252 kJ
Comparison		$W_{arc} < W_{arc, prot\_APC 2}$	YES
		$W_{arc} < W_{arc, prot\_APC 1}$	NO
Calculation results:			<b>APC 2</b>

### A 5.8.2 Working in the vicinity of the inverter (DC intermediate circuit, Work location 2)

*Phase 3: Apply the calculation methodology: Determine  $W_{arc}$ ,  $W_{arc, prot}$ !*

At the fault location, a conductor spacing of  $d = 20$  mm is assumed, which yields a current limiting factor of  $k_B = 0.710$  and an actual fault current (electric arc short-circuit current) of  $I_{k, arc} = 2.9$  kA. The system is shut down by the fuse because the fault occurred within its protection zone. Using the manufacturer's data sheet results in an NH gR Bat 500 A fuse for the fault current of 2.9 kA with a trip time of  $t_k = 210$  ms (refer to Fig. A 5-24).

For electric arc power, the iteration calculation yields  $P_{arc} = 337$  kW, which corresponds to a normalized arc power of  $k_P = 0.206$ . With a short-circuit duration of  $t_k = 210$  ms, the resulting expected value for converted electric arc energy at the work location (fault location) is  $W_{arc} = 70.7$  kJ.

If electric arc power is calculated with a worst-case estimation (without considering the electrode gap) for the relationship of  $P_{arc} = 0.25 P_k$  with the network parameters for network voltage level, prospective short-circuit current and the short-circuit power at  $P_K = U_N \cdot I_{kDC}$ , then it follows that  $P_{arc, max} = 0.25 \cdot 1.634$  MVA = 408,5 kW. The resulting expected value for arc energy is then  $W_{arc, max} = 85.8$  kJ.

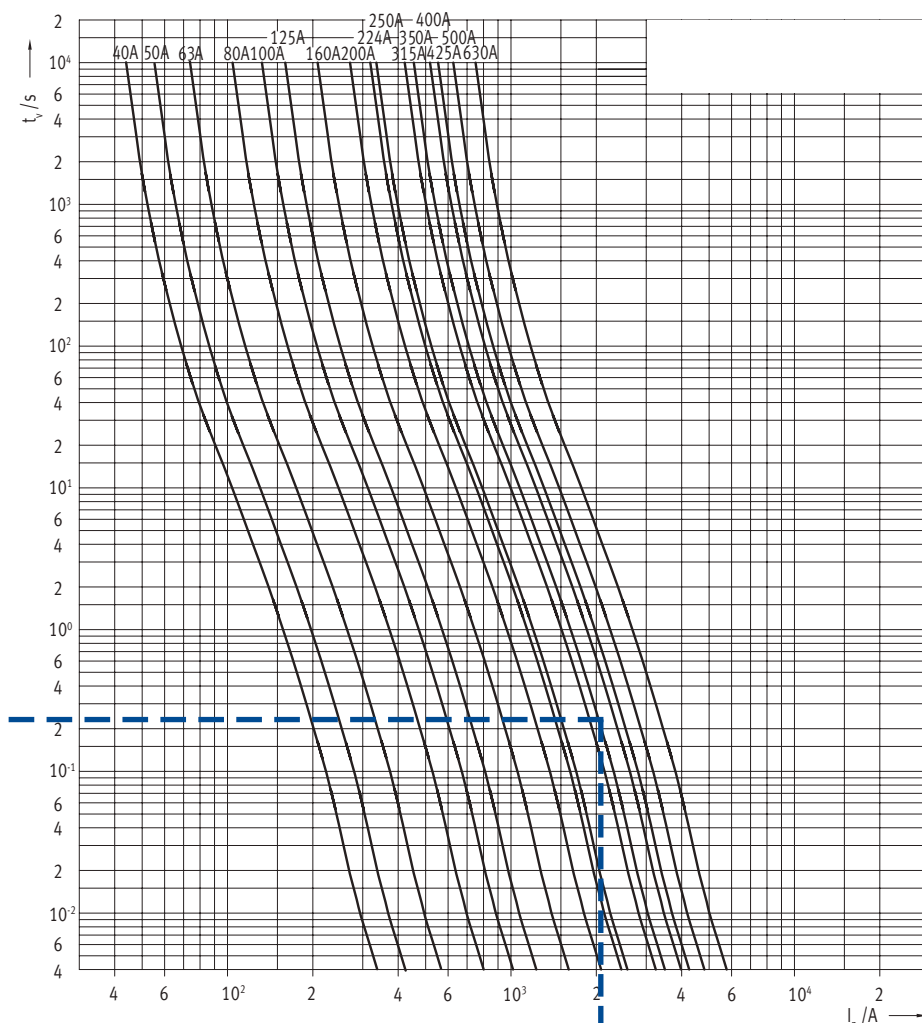

Fig. A 5-24 Mean time/current characteristic curves for the NH gR Bat line protection fuse being considered

The PPEaA protection level is determined from the arc energy test level with consideration given to the transmission relationships and working distance  $a$ . If one assumes standard conditions related to a small-scale system volume (with side and rear panels), which correspond to a transmission factor of  $k_T = 1.0$  and a distance of  $a = 300$  mm, then the PPEaA protection level  $W_{arc, prot}$  will be identical with the test level  $W_{arc, test}$ . The protection level under these conditions for PPEaA in the Arc protection class APC 1 are  $W_{arc, test} = 168$  kJ, so that work can be carried out at the Work location in question with PPEaA in the Arc protection class APC 1.

In the event of divergent system conditions, greater values for the transmission factor and the working distance will result, so that the protection level according to  $W_{arc, prot} = k_T \cdot (a / 300 \text{ mm})^2 \cdot W_{arc, test}$  will also assume a higher level. It follows that that work under these circumstances with PPEaA in the Arc protection class APC 1 is possible.

The calculations are depicted in the form of work steps in the overview Table A 5-13.

**Table A 5-13** Summary of the example for work on UPS systems at Work location 2

<b>Work location</b>	Working on a battery system	Prepared by:	John Doe
<b>Work order</b>	200 kVA UPS system	Date:	29 Nov. 2019

Calculation	Parameter	Result	
Network parameter	Nominal voltage	$U_{Nn}$	400V
Equipment geometry	Conductor spacing	$d$	20 mm
Short-circuit current calculation	Sustained short-circuit current	$I_{kDC}$	4.09 kA
	Time constant $\tau$	$\tau$	0.002 s
Current limitation		$k_B$	0.71
Electric arc current (fault current)	$I_{k, arc (i+1)} = \frac{U_{Nn}}{\frac{(34 + 0.532 \cdot d)}{I_{k, arc (i)}^{0.88}} + \frac{U_{Nn}}{I_{kDC}}}$	$I_{k, arc} =$	2.90 kA
Trip time for the overcurrent protection device (circuit breaker set value/ Trip time from the protection fuse characteristic curve)		$t_k$	0.210 s
Short-circuit power	$P_k = U_{Nn} \cdot I_{kDC}$	$P_k =$	1.6 MW
Electric arc power	$P_{arc} = U_{arc} \cdot I_{k, arc}$	$P_{arc} =$	0.34 MW
Normalized arc power	$k_p = P_{arc} / P_k$	$k_p =$	0.206
Electric arc energy (expected value)	$W_{arc} = P_{arc} \cdot t_k$	$W_{arc} =$	70.72 kJ
Working distance		$a$	300 mm
Standardized PPE test level		$W_{arc, test\_APC 2} =$	320 kJ
		$W_{arc, test\_APC 1} =$	168 kJ
Transmission factor		$k_T$	1.0
PPEaA protection level at the point of arcing	$W_{arc, prot} = k_T \cdot \left(\frac{a}{300 \text{ mm}}\right)^2 \cdot W_{arc, test}$	$W_{arc, prot\_APC 2} =$	320 kJ
		$W_{arc, prot\_APC 1} =$	168 kJ

<b>Comparison</b>	$W_{arc} < W_{arc, prot\_APC 2}$	YES
	$W_{arc} < W_{arc, prot\_APC 1}$	YES

<b>Calculation results:</b>	<b>APC 1</b>
-----------------------------	--------------

### A 5.9 Example 5.9: Working on DC installations (traction network)

#### Working on a rectifier substation in the output circuitry downstream from the supply circuit breaker

In the DC supply system, each section of tracking line is supplied by a parallel connection (refer to Fig. A 5-25). Work is foreseen on substation A in the output circuitry. The substation is accordingly supplied from two sides: via supply line SL A as well as with supply line SL B via substation B and the tracking line FL.

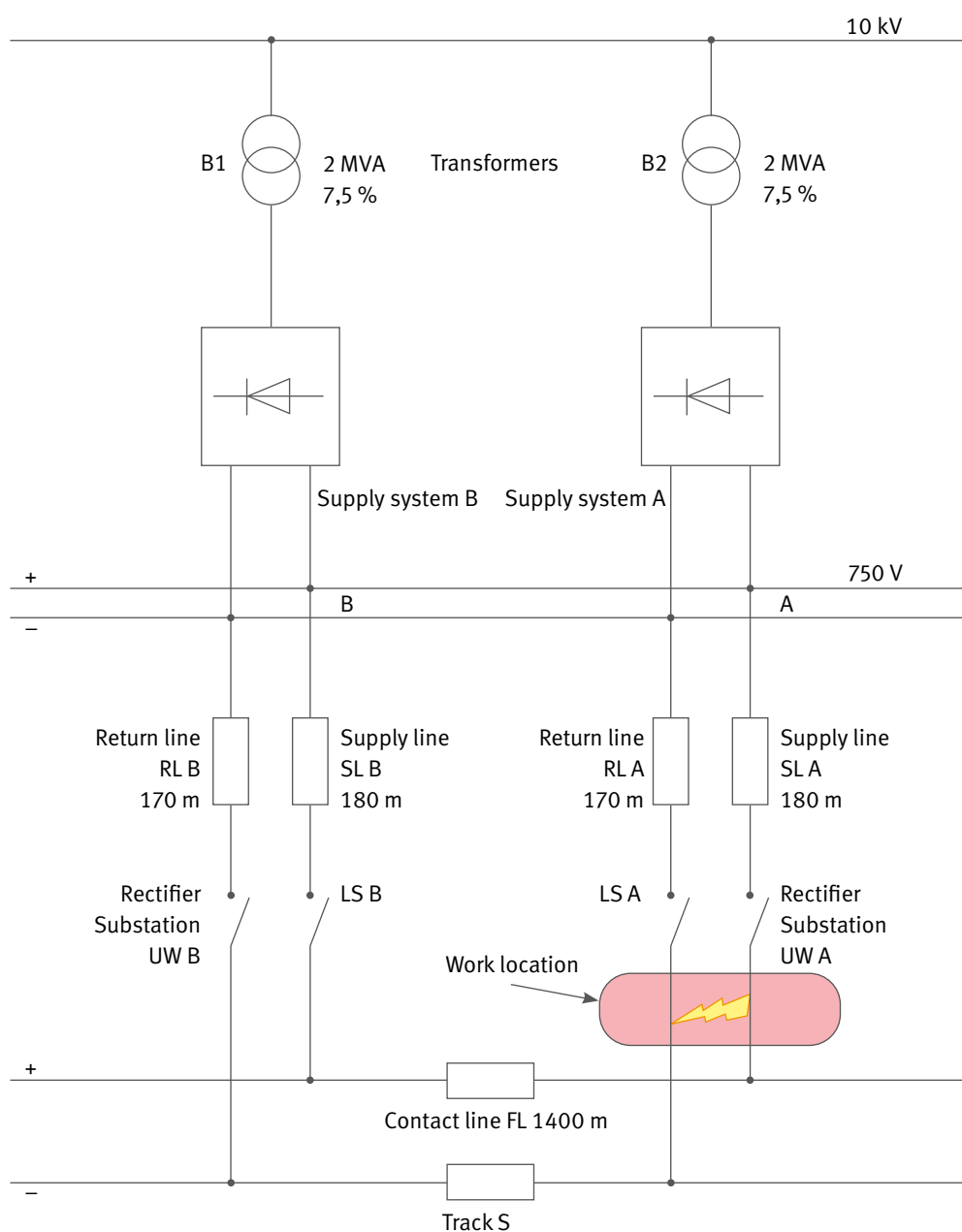

Fig. A 5-25 Equivalent circuit diagram for the DC traction power supply work location

### Risk assessment of the planned activities

*Phase 1: Is there a principle danger of exposure to persons due to electric arcing?*

- Yes.
- For the work areas associated with substations A or B, the potential for electric arcing cannot be ruled out.

*Phase 2: Initial evaluation of electric arc energy associated with the scope of activity or workplace. Is a calculation required?*

- Yes.
- None of the requirements listed in Section 1, in which the use of PPEaA can be dispensed with, have been fulfilled.

*Phase 3: Apply the calculation methodology: Determine  $W_{\text{arc}}$ ,  $W_{\text{arc, prot}}$ !*

Under consideration is the work-related introduction of a short-circuit in the output section of inverter UW A, downstream from feed circuit breaker LS A. With a two-sided supply, a fault circuit develops that leads via the parallel connection of the branch with feeding line SL A and circuit breaker LS A and of the branch with feeding line SL B, the substation B with circuit breaker LS B, the traction line FL, the fault location in substation UW A and the branch with return line RL B to substation UW B and the track rail S.

A suitable switching state is initially established for work in the substation, in which a one-sided supply is selected. In the parallel circuits, the branches with inverter UW A's supply line SL A and return line RL A each possess low resistance. For this reason, the feed circuit breaker for inverter UW A is switched off prior to beginning work. The level of short-circuit current is reduced accordingly so that, in the event of a fault, low power and energy levels will be converted into an arc flash.

When a short-circuit occurs, the location of the fault at the work location will be supplied only via inverter UW B (short-circuit electrical circuit via supply line SL B, closed circuit breaker LS B and contact line FL, fault location, track S and return line RL B. Shutdown of the fault takes place via circuit breaker LS B in the subsection of inverter UW B.

At the work location or fault location in question, a prospective short-circuit current of  $I_{\text{kDC}} = 6.54 \text{ kA}$  with a network voltage of 807 V has been determined and has also been verified by measurements taken during short-circuit testing. At the fault location, a conductor spacing of  $d = 30 \text{ mm}$  is assumed, which yields a current limiting factor of  $k_B = 0.826$  and an actual fault current (electric arc short-circuit current) of  $I_{\text{k, arc}} = 5.4 \text{ kA}$ . The circuit breaker LS B in inverter UW B (static trigger set at 5 kA) shuts down the fault circuit at a short-circuit duration  $t_k = 100 \text{ ms}$  (with di/dt protection, the circuit breaker switch-off time is generally even faster).

For electric arc power, the iteration calculation yields  $P_{\text{arc}} = 760 \text{ kW}$ , which corresponds to a normalized arc power of  $k_p = 0.143$ . With a short-circuit duration of  $t_k = 100 \text{ ms}$ , the resulting expected value for converted electric arc power at the work location (fault location) is  $W_{\text{arc}} = 75.7 \text{ kJ}$ .



If electric arc power is calculated with a worst-case estimation (without considering the electrode gap) for the relationship of  $P_{\text{arc}} = 0.25 P_K$  with the network parameters for network voltage level, prospective short-circuit current and the short-circuit power at  $P_K = U_N \cdot I_{\text{kDC}}$ , it follows that  $P_{\text{arc,max}} = 0.25 \cdot 5,3 \text{ MVA} = 1.325 \text{ MW}$ . The resulting expected value for arc energy is then  $W_{\text{arc,max}} = 133 \text{ kJ}$ .

The PPEa protection level is determined from the arc energy test level with consideration given to the transmission relationships and the working distance  $a$ . If one assumes standard conditions related to a small-scale system volume (with side and rear panels), which correspond to a transmission factor of  $k_T = 1.0$  and a distance of  $a = 300 \text{ mm}$ , then the PPEa protection level  $W_{\text{arc,prot}}$  will be identical with the test level  $W_{\text{arc,test}}$ . The protection level under these conditions for PPEa in the Arc protection class APC 1 is  $W_{\text{arc,test}} = 168 \text{ kJ}$ , so that work can be carried out at the work location in question with PPEa in the Arc protection class APC 1.

In the event of divergent system conditions, greater values for the transmission factor and the working distance will result, so that the protection level according to  $W_{\text{arc,prot}} = k_T \cdot (a / 300 \text{ mm})^2 \cdot W_{\text{arc,test}}$  will also assume a higher level. It follows that that work under these circumstances with PPEa in the Arc protection class APC 1 is possible.

The calculations are depicted in the form of work steps in the overview Table A 5-14.

**Table A 5-14** Summary for the example of work in the outgoing branch of the rectifier substation

<b>Work location</b>	Rectifier substation A, output section	Prepared by:	John Doe
<b>Work order</b>	Cleaning work	Date:	29 Nov. 2019
<b>Calculation</b>		Parameter	Result
Network parameter	Nominal voltage	$U_{Nn}$	807 V
Equipment geometry	Conductor spacing	$d$	30 mm
Short-circuit current calculation	Sustained short-circuit current	$I_{kDC}$	6.54 kA
	Time constant $\tau$	$\tau$	0.030 s
Current limitation		$k_B$	0.826
Electric arc current (fault current)	$I_{k, \text{arc}}^{(i+1)} = \frac{U_{Nn}}{\frac{(34 + 0.532 \cdot d)}{I_{k, \text{arc}}^{(i)}} + \frac{U_{Nn}}{I_{kDC}}}$	$I_{k, \text{arc}} =$	5.40 kA
Trip time for the overcurrent protection device (circuit breaker set value/ Trip time from the protection fuse characteristic curve)		$t_k$	0.100 s
Short-circuit power	$P_k = U_{Nn} \cdot I_{kDC}$	$P_k =$	5.3 MW
Electric arc power	$P_{\text{arc}} = U_{\text{arc}} \cdot I_{k, \text{arc}}$	$P_{\text{arc}} =$	0.76 MW
Normalized arc power	$k_p = P_{\text{arc}} / P_k$	$k_p =$	0.143
Electric arc energy (expected value)	$W_{\text{arc}} = P_{\text{arc}} \cdot t_k$	$W_{\text{arc}} =$	75.71 kJ
Working distance		$a$	300 mm
Standardized PPE test level		$W_{\text{arc, test\_APC 2}} =$	320 kJ
		$W_{\text{arc, test\_APC 1}} =$	168 kJ
Transmission factor		$k_T$	1.0
PPEaA protection level at the point of arcing	$W_{\text{arc, prot}} = k_T \cdot \left(\frac{a}{300 \text{ mm}}\right)^2 \cdot W_{\text{arc, test}}$	$W_{\text{arc, prot\_APC 2}} =$	320 kJ
		$W_{\text{arc, prot\_APC 1}} =$	168 kJ
<b>Comparison</b>		$W_{\text{arc}} < W_{\text{arc, prot\_APC 2}}$	YES
		$W_{\text{arc}} < W_{\text{arc, prot\_APC 1}}$	YES
<b>Calculation results:</b>			<b>APC 1</b>

# Annex 6

Exemplary work locations for determining transmission factor  $k_T$



Fig. A 6-1 Working on a house junction box:  $k_T = 1.0$



Fig. A 6-2 Replacement of a fuse panel in a control cabinet (close to the side wall):  $k_T = 1.0$



Fig. A 6-3 Working on a cable distribution cabinet:  $k_T = 1.5$



Fig. A 6-4 Working on a compact station:  $k_T = 1.7$



Fig. A 6-5 Installing cable sleeves:  $k_T = 1.9$



Fig. A 6-6 Working on an electricity pole:  $k_T = 2.4$

# Annex 7

## Coordination of PPEaA and pre-fuses

### A 7.1 Practical rules of application for the coordinated selection of PPEaA and backup fuse

The following discussion considers the rules to apply for a coordinated application of PPEaA in conjunction with the use of short-circuit protection devices in the form of fuses for the low voltage range in AC systems.

The rules of application are valid for 400 V systems (three-phase AC system) and standard exposure conditions:

Working distance:  $a = 300 \text{ mm}$

Transmission factor:  $k_T = 1$  (small-scale installation volume).

The rules of application exist in 3 different forms, which can be optionally applied:

A1: Selection matrix

A2: Minimum overcurrent factor

A3: Permissible NH fuse trip time.

They are distinguished by their degree of simplification, accuracy and the type of manual handling. Separate considerations for 3-pole and 2-pole short-circuits (arcing fault) are possible.

The prospective short-circuit current, unaffected by electric fault arcing (bolted short-circuit), serves merely as a respective input variable resulting from the short-circuit current calculation; it is to be set as the initial short-circuit AC current  $I''_{k,\max}$ <sup>1</sup>.

### A 7.2 Selection matrix

The selection diagram that follows is applicable for the different operating classes of NH fuses for 2-pole and 3-pole short-circuits:

- Fig. A 7-1 to A 7-4 Line protection fuse, operating class NH gG
- Fig. A 7-5 to A 7-6 Transformer protection fuse, operating class NH gTr
- Fig. A 7.7 Safe-work fuse (operating class aR, gR, ...).

The selection or examination of the circuit protector is facilitated by means of classification by fuse current rating and short-circuit current range in the form of a matrix (requirement: Standard exposure conditions). The smallest respective value of permissible short-circuit current (minimum short-circuit current) can be read out. This is required in order to achieve a level of protection with the PPEaA together with a specific fuse.

Permissible conditions (protection guaranteed) are marked respectively “green”; in contrast, the “red” fields depict inadmissible conditions (protection not warranted).

It should be noted in general that personal protection (prevention of skin burns) can be viewed as warranted under standard exposure conditions with short-circuit currents below 1 kA, independent of the rated current.

---

<sup>1</sup> The actual flowing electric arc short-circuit currents have smaller values.

### A 7.3 Line protection fuses

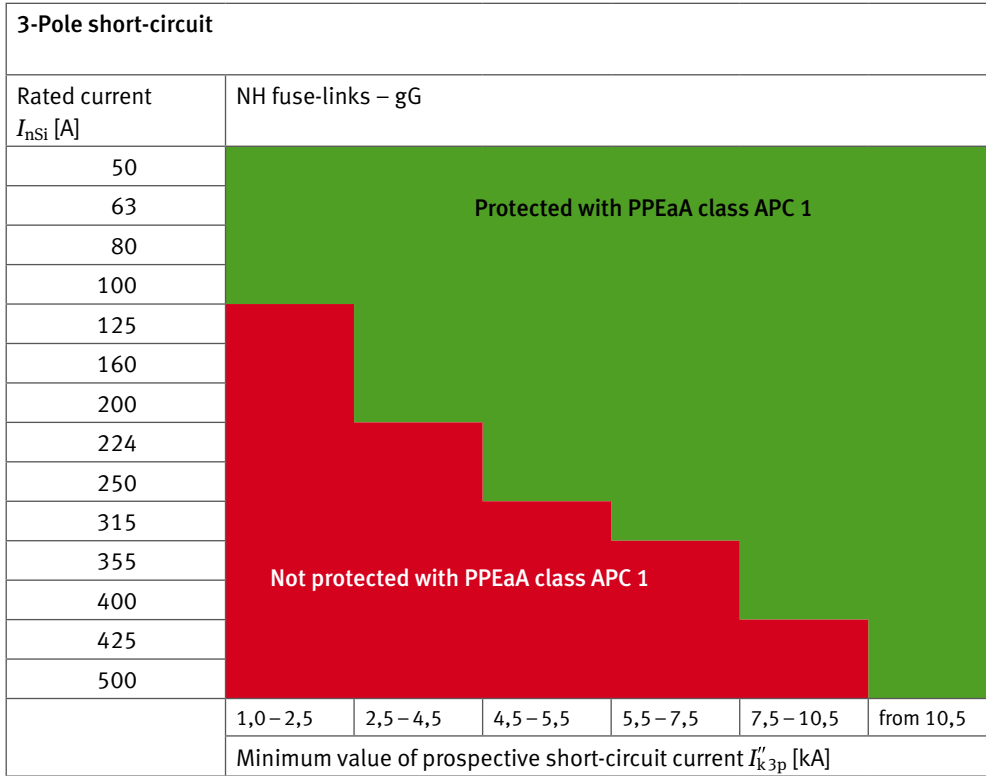

Fig. A 7-1  
Selection of NH gG fuses with PPEaA in the Arc protection class APC 1 for 3-pole short-circuits

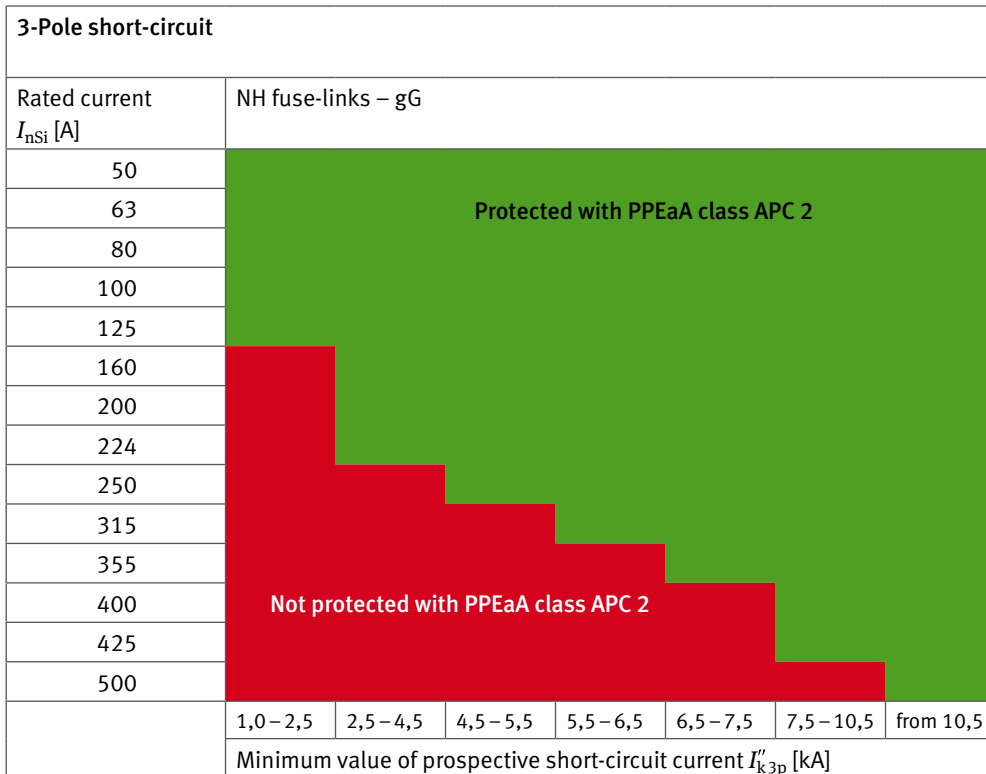

Fig. A 7-2  
Selection of NH gG fuses with PPEaA in the Arc protection class APC 2 for 3-pole short-circuits

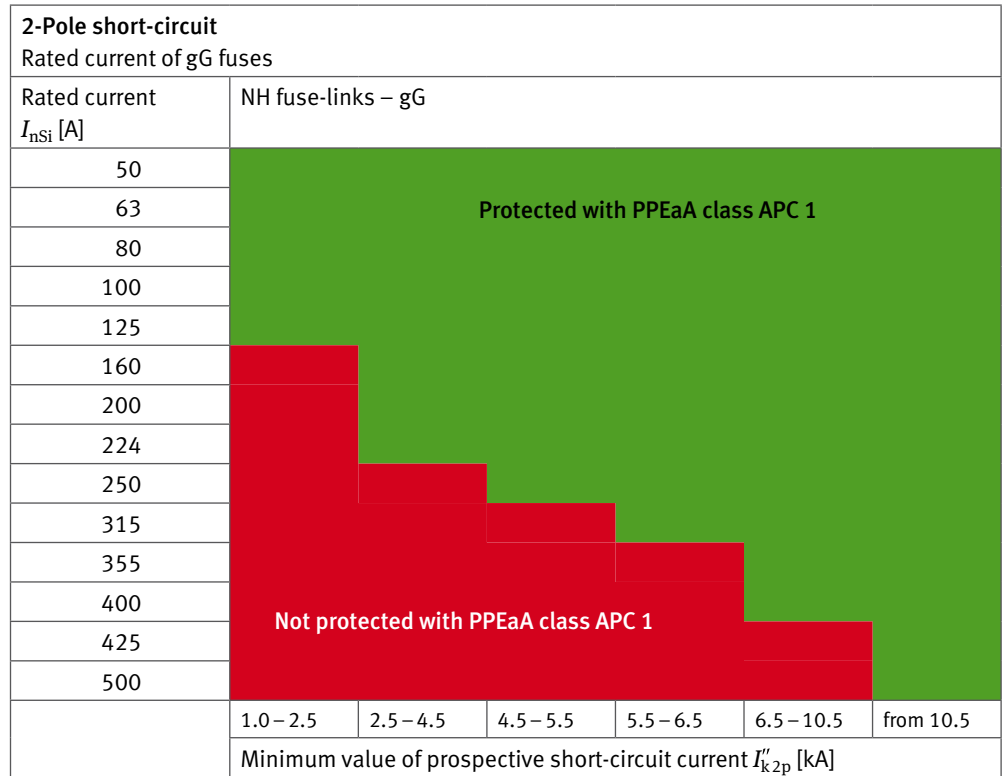

Fig. A 7-3  
Selection of NH gG fuses with PPEaA in the Arc protection class APC 1 for 2-pole short-circuits

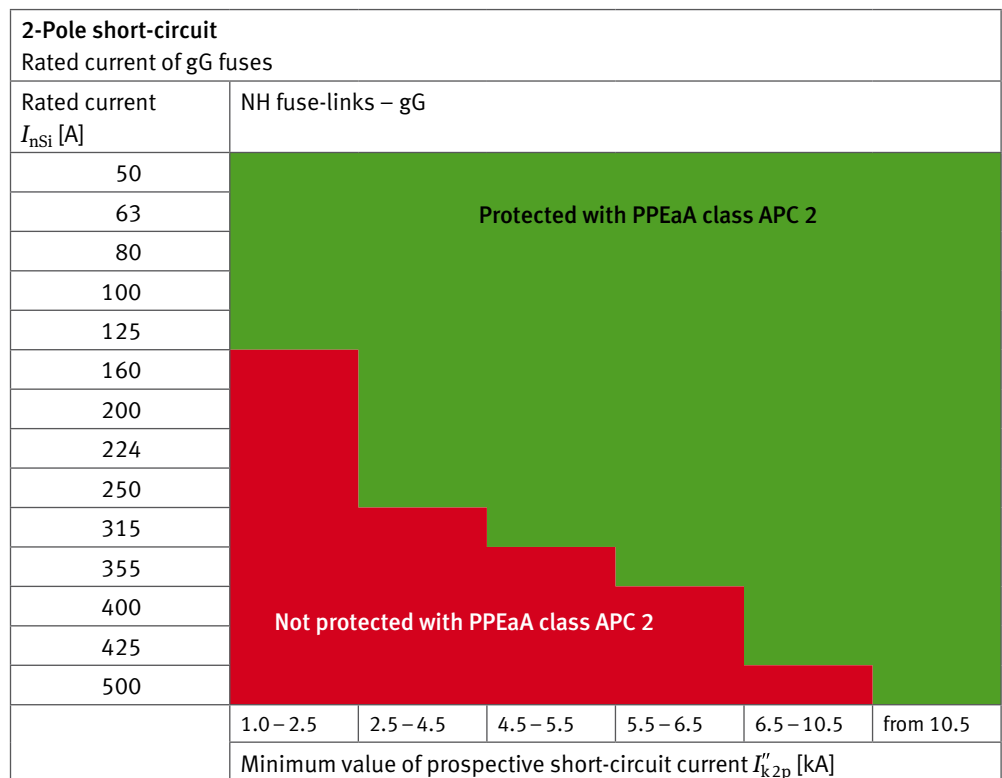

Fig. A 7-4  
Selection of NH gG fuses with PPEaA in the Arc protection class APC 2 for 2-pole short-circuits



Example of NH gG line protection fuses:

The prospective 3-pole short-circuit current equals 3.614 kA. The range from 2.5 to 4.5 kA is appropriate; according to Fig. A 7-1, PPEa in the Arc protection class APC 1 offers protection together with circuit protection with rated currents up to 200 A. If a 224 A fuse is present, then the PPEa in the Arc protection class APC 1 does not provide sufficient protection anymore (according to Fig. A 7-2 in this case, sufficient protection will be provided using PPEa in the Arc protection class APC 2).

### A 7.4 Transformer protection fuses

With 3-pole short-circuits (under standard exposure conditions):

- When using gTr fuses  $\leq 250$  kVA (361 A), protection is warranted only
  - through PPEa in the Arc protection class APC 2 and
  - if the short-circuit current equals at least 7 kA.
- When using gTr fuses  $> 250$  kVA (361 A), neither PPEa in the Arc protection class APC 1 nor PPEa in the Arc protection class APC 2 will allow for protection to be realized.

For 2-pole short-circuits, the assertions on Fig. A 7-5 and Fig. A 7-6 apply.

<b>2-Pole short-circuit</b>	
Rated current of gTr fuses	
Apparent power $S_n$ [kVA] ( $I_{rat}$ [A])	NH fuse-links – gTr
250 (361)	Protected with PPEa class APC 1
315 (455)	Not protected with PPEa class APC 1
400 (577)	
	4.5 – 10.5
	from 10.5
	Minimum value of prospective short-circuit current $I''_{k2p}$ [kA]

Fig. A 7-5  
Selection of NH gTr fuses with PPEa in the Arc protection class APC 1 for 2-pole short-circuits

<b>2-Pole short-circuit</b>	
Rated current of gTr fuses	
Apparent power $S_n$ [kVA] ( $I_{rat}$ [A])	NH fuse-links – gTr
250 (361)	Protected with PPEa class APC 2
315 (455)	Not protected with PPEa class APC 2
400 (577)	
	4.5 – 7.5
	from 7.5
	Minimum value of prospective short-circuit current $I''_{k2p}$ [kA]

Fig. A 7-6  
Selection of NH gTr fuses with PPEa in the Arc protection class APC 2 for 2-pole short-circuits

### A 7.5 Safe-work fuses

The limits for the conditions, under which protection is provided through PPEa in both Arc protection class APC 1 and Arc protection class APC 2 with both 2-pole and 3-pole short-circuits, are identical. This means that, within the permissible areas, sufficient protection is provided by PPEa in the Arc protection class APC 1 and the use of PPEa in the Arc protection class APC 2 will not enhance the scope of coverage. The selection diagram is applicable for both 2-pole as well as with 3-pole short-circuits. It should be noted

here, that short-circuit currents for the same installation with 3-pole and 2-pole short-circuits are distinguished in level by a factor of  $2/\sqrt{3} \approx 1.155$ .

3-Pole short-circuit / 2-Pole short-circuit			
Rated current $I_{nSi}$ [A]	NH fuse-links – safe-work		
160	Protected with PPEaA class APC 1 (and PPEaA class APC 2)		
200			
250			
315			
355			
400	Not protected with PPEaA class APC 1 or PPEaA class APC 2		
500			
	1.0 – 2.5	2.5 – 4.5	from 4.5
	Minimum value of prospective short-circuit current $I''_{k2p}$ [kA]		
	Minimum value of prospective short-circuit current $I''_{k3p}$ [kA]		

Fig. A 7-7

Selection of NH safe-work fuses with PPEaA in the Arc protection classes APC 1 and APC 2 for 2-pole and 3-pole short-circuits

### A 7.6 Minimum overcurrent factor

Table A 7-1 Minimum overcurrent factor

NH fuse operating class	PPEaA Arc protection class	Minimum overcurrent factor $k_{\dot{U},mind}$	
		2-Pole short-circuit	3-Pole short-circuit
gG	APC 1	20	
	APC 2	18	19
gTr	APC 1	28	
	APC 2	25	
Safe-work	APC 1	6	8
	APC 2		

Using the minimum overcurrent factor  $k_{\dot{U},mind}$  and the prospective short-circuit current  $I''_k$ , a very rough determination of the (maximum) permissible rated current  $I_{nSi,max}$  of the pre-fused circuit can be undertaken for standard exposure conditions, which results in personal protection in conjunction with PPEaA:

$$I_{nSi,max} = \frac{I''_k}{k_{\dot{U},mind}}$$

with

$I_{nSi,max}$  Maximum value of the fuse current rating in A

$I''_k$  Prospective short-circuit current (2-pole or 3-pole) in A

$k_{\dot{U},mind}$  Minimum overcurrent factor

The rated current for the pre-fused circuit must not exceed this value so that the personal protection afforded by the PPEaA in the specified Arc protection class remains warranted.

Example:

With a prospective short-circuit current of  $I''_{k3p} = 5.472$  kA, in order to retain personal protection using PPEaA in the Arc protection class APC 1 with the use of gG-NH fuses, the resulting maximum value for permissible rated current would be

$$I_{nSi,max} = \frac{I''_{k3p}}{k_{\dot{U},mind}} = \frac{5472}{20} = 273.6 \text{ A}$$

A fuse must be selected with  $I_{nSi} \leq 273.6$  A; it follows that the greatest possible fuse would be NH gG 250 A.

## A 7.7 Permissible fuse trip times

On the basis of the prospective short-circuit current under standard exposure conditions and using the characteristic curve factor  $f_{KL}$  (refer to Table A 7-2), the permissible fuse trip time  $t_{kzul}$  can be determined based on

$$t_{kzul} = \frac{f_{KL}}{I''_k} \cdot \left( \frac{a}{300 \text{ mm}} \right)^2 \cdot k_T$$

with

- $t_{kzul}$  Permissible trip time in s
- $f_{KL}$  Characteristic curve factor in As
- $I''_k$  2-pole or 3-pole short-circuit current in A
- $a$  Working distance in mm
- $k_T$  transmission factor.

**Table A 7-2** Characteristic curve factor for fuse-links

Characteristic curve factor $f_{KL}$ in As		
PPEaA in the Arc protection class	2-Pole short-circuit	3-Pole short-circuit
APC 1	1000	500
APC 2	2000	1000

Example:

The precondition of a 2-pole short-circuit with the short-circuit current equalling 5 kA using PPEaA in the Arc protection class APC 1 results in a permissible fuse trip time

$$t_{kzul} = 1000 \text{ As} / 5000 \text{ A} = 0.2 \text{ s} = 200 \text{ ms.}$$

A fuse should be selected that does not exceed a trip time of 200 ms<sup>2</sup>.

Further information regarding the coordination of PPEaA with pre-fused circuits can be found at [22].

<sup>2</sup> For practical applications, a comparison should be made between the permissible trip time and the anticipated trip time of the selected or existing NH fuse. The anticipated trip time should be determined on the basis of the actual fault current (electric arc short-circuit current, not prospective short-circuit current – refer to 4 or Annex 3) from the current-time characteristic provided by the manufacturer for the fuse.

# Annex 8

## Selection guide worksheets

Two Excel files are available for download at the Internet address [www.dguv.de](http://www.dguv.de); Webcode: d1183022 to provide support in completing the Risk assessment. Individual tabs from both files are depicted on the follow pages.



### Form for calculating the Arc protection class for PPEaA

**AC**

Work location:	Low voltage transformer station, main distribution switchgear	Processor:	John Doe
Work order:	Connection/disconnection of output circuitry, measurement and testing or cleaning tasks	Date:	29.11.19
Network voltage:	400 V		
Max. short-circuit current:	24,50 kA		
Min. short-circuit current:	21,60 kA		
Distance between conductors:	60,0 mm		
R/X ratio (Section 4.2.2)	0,27	Rationale:	none
Current limiting factor $k_B$ (Section 4.2.2)	0,50	Rationale:	none
Protection device:	gTr AC 400 V fuse (... manufacturer ...)		
Trip time for Overcurrent protection device $t_p$ :	0,113 s	Note: (Circuit breaker set value / Trip time from fuse characteristics)	
Transmission factor $k_T$ (Section 4.2.3)	1,50	Rationale:	none
Distance of person from electric arc source location a:	300 mm		
Results:	<b>Isolate or take other measures</b>		<b><u>Conduct a Risk assessment</u></b>

**Adopting the following measures would facilitate working:**

Shorten the upstream protection device trip time to < 0,041 s for PPEaA in the Arc protection class APC 1 or to < 0,078 s for PPEaA in the Arc protection class APC 2.  
Increase the working distance to  $\geq 498$  mm for PPEaA in the Arc protection class APC 1 or to  $\geq 361$  mm for PPEaA in the Arc protection class APC 2.

Fig. A 8-1 Input form for the calculation (AC)

AC Calculation		Parameters	Results
Network parameters	Network voltage	$U_{N0}$	400,0 V
	Conductor spacing	$d$	60 mm
Calculation	Max. short-circuit current	$I_{k3p\ max}$	24,5 kA
	Min. short-circuit current	$I_{k3p\ min}$	21,6 kA
	R/X ratio	$R/X$	0,3
Current limiting factor		$k_B$	0,500
Minimum fault current	$I_{k_{arc}} = k_B \cdot I_{k3p\ min}$	$I_{k_{arc}}$	10,80 kA
NH fuse characteristics (Fig. 5-4)		$t_k$	0,113 s
Short-circuit power	$S_k = \sqrt{3} \cdot U_{N0} \cdot I_{k3p\ max}$	$S_k$	17,0 MVA
Normalized arc power [21]	$k_p = 0,29 / (R/X)^{0,17}$	$k_p$	0,36
Electric arc power	$P_{arc} = k_p \cdot S_k$	$P_{arc}$	6,1 MW
Electric arc energy (expected value)	$W_{arc} = k_p \cdot S_k \cdot t_k$ (assumption: $k_p = k_{pmax}$ )	$W_{arc}$	694,9 kJ
Arc protection classes for PPEaA (according to Box Test parameters)		$W_{arc, test\_APC2}$	320,0 kJ
		$W_{arc, test\_APC1}$	168,0 kJ
System parameters	Transmission factor	$k_T$	1,5
Working procedures	Distance of person to electric arc source location	$a$	300 mm
Protection level of PPEaA at the point of arcing (extrapolation of Box Test parameters to the point of arcing)		$W_{arc, prot\_APC2}$	480,0 kJ
		$W_{arc, prot\_APC1}$	252,0 kJ
Calculation of max. switch-off time - Class APC 2		$t_{s\_APC2}$	0,078 s
Calculation of max. switch-off time - Class APC 1		$t_{s\_APC1}$	0,041 s
Calculation of min. distance - Class APC 2		$a_{APC2}$	361 mm
Calculation of min. distance - Class APC 1		$a_{APC1}$	498 mm
Relationship	Ratio $W_{arc} / W_{arc, prot}$ - Class APC 2	$W_{arc} / W_{arc, prot\_APC2}$	1,45
	Ratio $W_{arc} / W_{arc, prot}$ - Class APC 1	$W_{arc} / W_{arc, prot\_APC1}$	2,76

AC

Isolate or take other measures **Conduct a Risk assessment**  
 Adopting the following measures would facilitate working:  
 Shorten the upstream protection device trip time to < 0,041 s for PPEaA in the Arc protection class APC 1 or to < 0,078 s for PPEaA in the Arc protection class APC 2.  
 Increase the working distance to ≥ 498 mm for PPEaA in the Arc protection class APC 1 or to ≥ 361 mm for PPEaA in the Arc protection class APC 2.

Fig. A 8-2 Depiction of the individual calculation results (AC)

Probability of injury due to electric fault arcing						AC
<b>Evaluation scheme</b>						
<b>Processor:</b>	John Doe	<b>Class:</b>	APC 2	<b>Date:</b>	29.11.19	
<b>Location / Type of activity:</b>	Low voltage transformer station, main distribution / Connection/disconnection of output circuitry, measurement and testing or cleaning tasks					Influence leads to probability of injury (0 = Practically impossible, 2 = Conceivable, but very unlikely, 4 = Unlikely, 7 = Seldom, 10 = Occasional to frequent)
<b>a) Type/condition of equipment</b>	Type/condition of equipment with respect to bridging of different potentials (arc flash formation) or limiting the impact of electric arcing	4				<b>Explanation:</b> Electric arc potential: 1. Stripping of a main cable, 2. Fault (short-circuit) at the junction
<b>b) Technical measures</b>	Technical measures to prevent potential of bridging (arc flash formation) or to limit the impact of electric arcing	2				<b>Explanation:</b> The use of a cable stripping device (alternative: cable stripping knife with a non-conducting blade)
<b>c) Organizational measures</b>	Organizational measures to prevent potential bridging (arc flash formation) or to limit the impact of electric arcing	2				<b>Explanation:</b> Live working - Low voltage directive/Live working - Low voltage work instructions: Testing for a fault-free state of the branch cable, e.g. by testing for isolation
<b>d) Personal measures</b>	Personal measures to prevent potential bridging (arc flash formation) or to limit the impact of electric arcing	2				<b>Explanation:</b> Special training for live working-low voltage, the use of PPEaA class APC 2
<b>e) Statistical influencing factors</b>	Statistical influencing factors that play a role when evaluating the probability of the occurrence of an electric arc injury due to electric arcing	4				<b>Explanation:</b> Injuries due to electric arcing while using PPEaA are not known, training for multi-pole electric fault arcs is very limited/rarely possible
<b>f) Ergonomic influencing factors</b>	Ergonomic influencing factors that play a role when evaluating the probability of the occurrence of an electric arc injury due to electric arcing	2				<b>Explanation:</b> Wearing comfort with PPEaA class APC2 may be constrained (face shield: heat build-up, condensation), working with a forced posture
<b>Summation of evaluation points:</b>						16,0
	Probability of injury	0 ...	10 ...	20 ...	31 ...	46 ...
<b>Severity of injury</b> $W_{arc} / W_{arc, prot}$		Practically impossible	Conceivable, but very unlikely	Unlikely	Seldom	Occasional to frequent
0 ...	Slight injury					
1 ...	Reversible injury		<b>APC 2</b>			
3 ...	Irreversible injury					
10 ...	Fatal injury					
APC 1		2,8				
APC 2		1,4				
<b>Results:</b>						It is permissible to carry out the work tasks using PPEaA class APC 2 on the basis of the evaluation approaches and the prescribed protection measures adopted

Fig. A 8-3 Input form for the evaluating the probability of occurrence (AC)

AC

Work location:	Low voltage transformer station, main distribution switchgear	Processor:	John Doe
Work order:	Connection/disconnection of output circuitry, measurement and testing or cleaning tasks	Date:	29.11.19

Calculation		Parameters	Results
Network parameters	Network voltage	$U_{Nn}$	400,0 V
Equipment geometry	Conductor spacing	d	60 mm
Short-circuit current calculation	Max. short-circuit current	$I_{k3p\ max}$	24,50 kA
	Min. short-circuit current	$I_{k3p\ min}$	21,60 kA
	R/X ratio	R/X	0,27
Current limitation		$k_B$	0,500
Minimum fault current	$I_{k,arc} = k_B * I_{k3p\ min}$	$I_{k,arc} =$	10,80 kA
Overcurrent protection device trip time (circuit breaker set value/trip time from the fuse characteristics)		$t_k$	0,113 s
Short-circuit power	$S_k^+ = \sqrt{3} * U_{Nn} * I_{k3p\ max}$	$S_k^+ =$	16,97 MVA
Normalized arc power	$k_p = 0.29 / (R/X)^{0.17}$	$k_p =$	0,362
Electric arc power	$P_{arc} = k_p * S_k^+$	$P_{arc} =$	6,15 MW
Electric arc energy (expected value)	$W_{arc} = k_p * S_k^+ * t_k$ (assumption: $k_p = k_{pmax}$ )	$W_{arc} =$	694,91 kJ
Working distance		a	300 mm
Standardized PPEaA test levels		$W_{arc, test\_APC2} =$	320,0 kJ
		$W_{arc, test\_APC1} =$	168,0 kJ
Transmission factor		$k_T$	1,50
Protection level of PPEaA at the point of arcing (extrapolation of Box Test parameters to the point of arcing)	$W_{arc, prot} = k_T * (\frac{a}{300\ mm})^2 * W_{arc, test}$	$W_{arc, prot\_APC2} =$	480,0 kJ
		$W_{arc, prot\_APC1} =$	252,0 kJ

Comparison	$W_{arc} / W_{arc, prot\_APC2}$	NO
	$W_{arc} / W_{arc, prot\_APC1}$	NO

<b>Results of the Calculation:</b>	<b>Isolate or take other measures</b>
<b>Results of the Risk assessment:</b>	<b>It is permissible to carry out the work tasks using PPEaA class APC 2 on the basis of the evaluation approaches and the prescribed protection measures adopted</b>

Rationale for the R/X ratio: none
Rationale for the Current limiting factor: none
Rationale for the Transmission factor: none
Protection device: gTr AC 400 V fuse (... manufacturer ...)

Fig. A 8-4 Printout of the results (AC)

		DC	
Work location:	200 kVA UPS system	Processor:	John Doe
Work order:	Perform work on an inverter	Date:	11.10.19
Network voltage:	400 V		
Sustained short-circuit current:	4,00 kA		
Conductor spacing:	30,0 mm		
Time constant $\tau = L/R$ :	2 ms	Rationale:	none
Protection device:	none		
Results for Arc current $I_{k,arc}$ : (Section 4.3)	2,71003 kA		
Trip time for Overcurrent protection device $t_k$ :	1,000 s	Note: Circuit breaker set value / trip time from fuse characteristics, by using $I_{k,arc}$	
Transmission factor $k_T$ : (Section 4.2.3)	1,50	Rationale:	none
Distance of person from electric arc source location a:	300 mm		
Results:	<b>Working with PPEa class APC 2 is permissible</b>		

Fig. A 8-5 Input form for the calculation (DC)

DC Calculation		Parameters	Results
Network parameters	Network voltage	$U_{N0}$	400,0 V
	Conductor spacing	$d$	30 mm
Calculation	Sustained short-circuit current	$I_{DC}$	4,0 kA
	Time constant $\tau = L/R$	$\tau$	0,002 s
Electric arc current (fault current)	$I_{k,arc}(t+s) = \frac{U_{N0}}{\sqrt{\left(\frac{34 + 0,532 \cdot d}{I_{k,arc}(t)}\right)^2 + \frac{U_{N0}^2}{I_{k,arc}^2(t)}}}$	$I_{k,arc} =$	2,71 kA
Electric arc voltage	$U_{arc} = (34 + 0,532 \cdot d) \cdot I_{k,arc}$	$U_{arc} =$	129,0 V
Current limiting factor	$k_B = I_{k,arc} / I_{DC}$	$k_B =$	0,678
NH fuse characteristics		$t_k$	1,000 s
Short-circuit power	$P_k = U_{N0} \cdot I_{DC}$	$P_k =$	1,6 MW
Electric arc power	$P_{arc} = U_{arc} \cdot I_{arc}$	$P_{arc} =$	0,3 MW
Normalized arc power	$k_p = P_{arc} / P_k$	$k_p =$	0,218
Electric arc energy (expected value)	$W_{arc} = P_{arc} \cdot t_k$	$W_{arc} =$	349,6 kJ
Arc protection class for PPEaA (according to Box Test parameters)		$W_{arc, test, APC2}$	320,0 kJ
		$W_{arc, test, APC1}$	168,0 kJ
System parameters	Transmission factor	$k_T$	1,5
Working procedures	Distance of person to electric arc source location	$a$	300 mm
Protection level of PPEaA at the point of arcing (extrapolation of Box Test parameters to the point of arcing)	$W_{arc, prot} = k_T \cdot (a/300 \text{ mm})^2 \cdot W_{arc, test}$	$W_{arc, prot, APC2} =$	480,0 kJ
		$W_{arc, prot, APC1} =$	252,0 kJ
	Calculation of max. switch-off time - Class APC 2	$t_{k, APC2}$	1,373 s
	Calculation of max. switch-off time - Class APC 1	$t_{k, APC1}$	0,721 s
	Calculation of min. distance - Class APC 2	$a_{APC2}$	256 mm
	Calculation of min. distance - Class APC 1	$a_{APC1}$	353 mm
Relationship	Ratio $W_{arc} / W_{arc, prot}$ - Class APC 2	$W_{arc} / W_{arc, prot, APC2}$	0,73
	Ratio $W_{arc} / W_{arc, prot}$ - Class APC 1	$W_{arc} / W_{arc, prot, APC1}$	1,39
Working with PPEaA class APC 2 is permissible			



Fig. A 8-6 Depiction of the individual calculation results (DC)

Probability of injury due to electric fault arcing						DC
Evaluation scheme						
Processor: John Doe		Class: APC2		Date: 11.10.19		<p>Influence leads to probability of injury (0 = Practically impossible, 2 = Conceivable, but very unlikely, 4 = Unlikely, 7 = Seldom, 10 = Occasional to frequent)</p> <p><b>Explanation:</b></p> <p><b>Explanation:</b></p> <p><b>Explanation:</b></p> <p><b>Explanation:</b></p> <p><b>Explanation:</b></p> <p><b>Explanation:</b></p> <p><b>Explanation:</b></p> <p><b>Results:</b></p> <p>It is permissible to carry out the work tasks using PPEaA Class APC2 on the basis of the evaluation approaches and the prescribed protection measures adopted</p>
Location / Type of activity: 200 kVA UPS system / Perform work on an inverter						
a) Type/condition of equipment		2				
Type/condition of equipment with respect to the potential capacity for bridging (arc flash formation) or limiting the impact of electric arcing, such as						
b) Technical measures		2				
Technical measures to prevent potential bridging (arc flash formation) or to limit the impact of electric arcing						
c) Organizational measures		N/A				
Organizational measures to prevent potential bridging (arc flash formation) or to limit the impact of electric arcing						
d) Personal measures		N/A				
Personal measures to prevent potential bridging (arc flash formation) or to limit the impact of electric arcing						
e) Statistical influencing factors		N/A				
Statistical influencing factors that play a role when evaluating the probability of an electric arc or injurious occurrence due to electric arcing						
f) Ergonomic influencing factors		N/A				
Ergonomic influencing factors that play a role when evaluating the probability of an electric arc or injury due to electric arcing						
Summation of evaluation points:		12,0				
Probability of injury		0 ...	10 ...	20 ...	31 ...	46 ...
Severity of injury		Practically impossible	Conceivable, but very unlikely	Unlikely	Seldom	Occasional to frequent
$W_{arc} / W_{arc, prot}$			APC2			
0 ...						
1 ...						
3 ...						
10 ...						
APC1 1,4						
APC2 0,7						

Fig. A 8-7 Input form for evaluating the probability of occurrence (DC)



DC

Work location: 200 kVA UPS system	Processor: John Doe
Work order: Perform work on an inverter	Date: 11.10.19

Calculation	Parameters	Results
Network parameters	Network voltage	$U_{Nn}$ = 400,0 V
Equipment geometry	Conductor spacing	$d$ = 30 mm
Short-circuit current calculation	Sustained short-circuit current	$I_{kDC}$ = 4,00 kA
	Time constant $\tau$	$\tau$ = 0,002 s
Current limitation	$k_B$	0,678
Electric arc current (fault current)	$I_{k,arc(i+1)} = \frac{U_{Nn}}{\frac{(34 + 0,532 \cdot d)}{I_{k,arc(i)}} + \frac{U_{Nn}}{I_{kDC}}}$	$I_{k,arc} =$ 2,71 kA
Overcurrent protection device trip time (circuit breaker set value/trip time from the fuse characteristics)	$t_k$	1,000 s
Short-circuit power	$P_k = U_{Nn} \cdot I_{kDC}$	$P_k =$ 1,6 MW
Electric arc power	$P_{arc} = U_{arc} \cdot I_{k,arc}$	$P_{arc} =$ 0,35 MW
Normalized arc power	$k_p = P_{arc} / P_k$	$k_p =$ 0,218
Electric arc energy (expected value)	$W_{arc} = P_{arc} \cdot t_k$	$W_{arc} =$ 349,59 kJ
Working distance	$a$	300 mm
Standardized PPE test level	$W_{arc, test\_APC 2} =$	320,0 kJ
	$W_{arc, test\_APC 1} =$	168,0 kJ
Transmission factor	$k_T$	1,50
Protection level of PPEaA at the point of arcing extrapolation of Box Test parameters to the point of arcing)	$W_{arc, prot\_APC 2} = k_T \times \left(\frac{a}{300\text{ mm}}\right)^2 \times W_{arc, test}$	480,0 kJ
		$W_{arc, prot\_APC 1} =$ 252,0 kJ

Comparison	$W_{arc} < W_{arc, prot\_APC 2}$	YES
	$W_{arc} < W_{arc, prot\_APC 1}$	NO

<b>Results of the Calculation:</b>	<b>Working with PPEaA class APC 2 is permissible</b>
<b>Results of the Risk assessment:</b>	<b>It is permissible to carry out the work tasks using PPEaA Class APC2 on the basis of the evaluation approaches and the prescribed protection measures adopted</b>

Rationale for the Time constant: none
Rationale for the Transmission factor: none
Protection device: none

Fig. A 8-8 Printout of the results (DC)





**Deutsche Gesetzliche  
Unfallversicherung e.V. (DGUV)**

Glinkastraße 40  
10117 Berlin, Germany  
Telephone: +49 30 13001-0 (switchboard)  
E-Mail: [info@dguv.de](mailto:info@dguv.de)  
Internet: [www.dguv.de](http://www.dguv.de)